

ofita



Servicio de Atención al Cliente
902 11 46 12
marketing@ofita.com

Customer Service
+34 945 263 700
com.exterior@ofita.com
www.ofita.com



sirimiri

| DESIGN KING & MIRANDA |

ofita

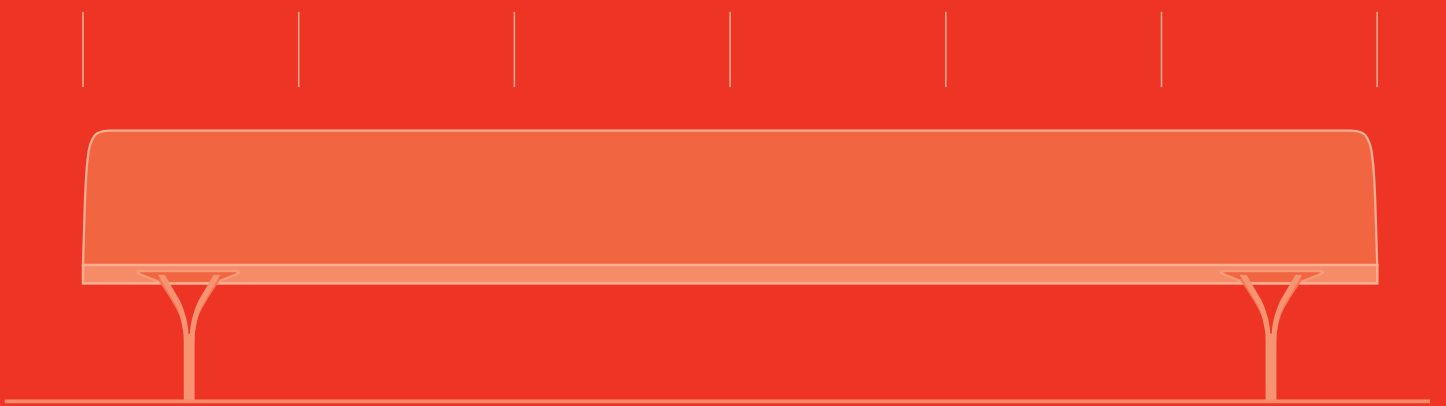

sirimiri

| banco para espacios colectivos |

| *bench for communal areas* |

| DESIGN KING & MIRANDA |





sirimiri

| Colección de bancadas de uso público, diseñada por King & Miranda Design. Fabricada en aluminio, Sirimiri está elaborada de una manera innovadora que le confiere gran ligereza estética y física, a la vez que la dota de gran robustez. Toma su nombre de esa lluvia finísima que moja pero que no se ve.

| *Collection of public benches designed by King & Miranda Design. Manufactured in aluminium, Sirimiri is created in an innovative way to give it great physical and aesthetic lightness whilst at the same time being very robust. Its name is derived from the word for drizzle, the fine rain which can be felt but not seen.*



| respaldo medio | 2 | 3 | 4 | 5 | 6 | asientos
| *medium backrest* | 2 | 3 | 4 | 5 | 6 | *seats*





| SIRIMIRI PRESENTA TRES MODELOS; DOS CON RESPALDO, MEDIO Y ALTO, Y UN TERCERO SIN RESPALDO

| SIRIMIRI IS AVAILABLE IN THREE MODELS; TWO WITH BACKREST, MEDIUM AND HIGH AND A THIRD WITHOUT BACKREST

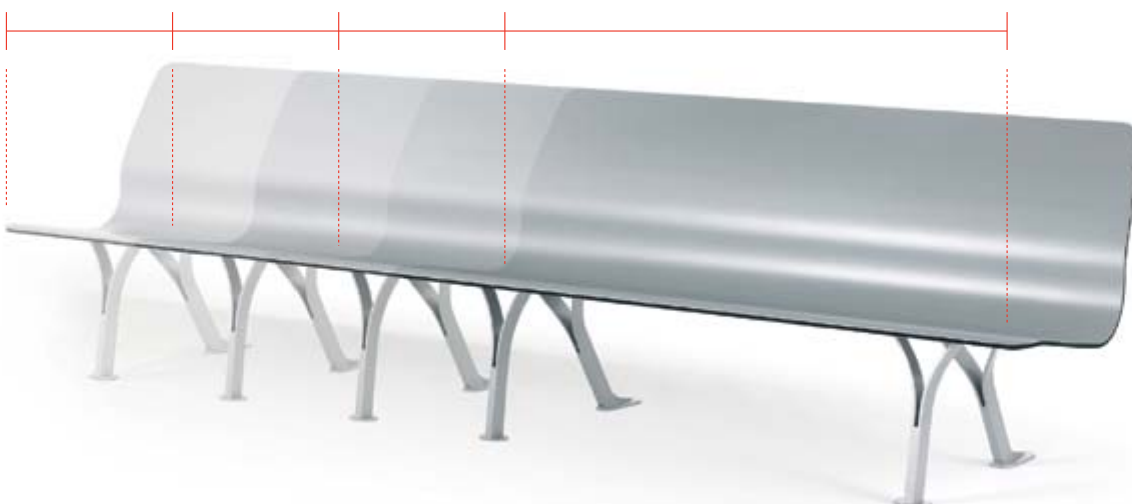



| respaldo alto | 2 | 3 | 4 | 5 | 6 | asientos
| high backrest | 2 | 3 | 4 | 5 | 6 | seats

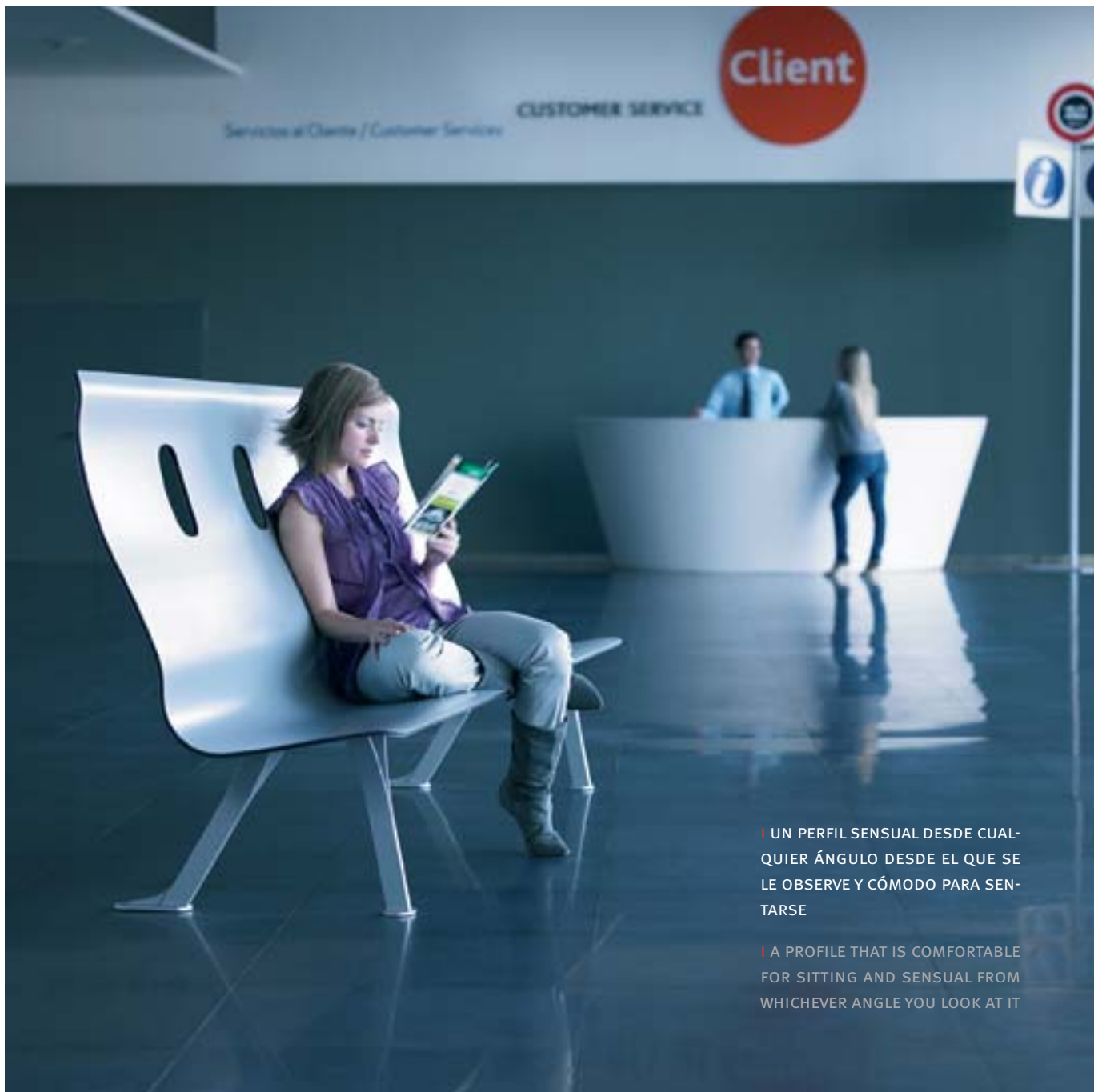

| UN PERFIL SENSUAL DESDE CUALQUIER ÁNGULO DESDE EL QUE SE LE OBSERVE Y CÓMODO PARA SENTARSE

| A PROFILE THAT IS COMFORTABLE FOR SITTING AND SENSUAL FROM WHICHEVER ANGLE YOU LOOK AT IT





| sin respaldo | 2 | 3 | 4 | 5 | 6 | asientos
| *without backrest* | 2 | 3 | 4 | 5 | 6 | *seats*

| EL RETO DE SIRIMIRI ES PEDIR A ELEMENTOS EXTREMAMENTE LIGEROS COMPORTARSE COMO ESTRUCTURAS AUTOPORTANTES EXTREMADAMENTE ROBUSTAS, CAPACES DE SOPORTAR NOTABLES ESFUERZOS

| THE CHALLENGE ADDRESSED BY SIRIMIRI IS TO REQUEST EXTREMELY LIGHTWEIGHT ELEMENTS TO BEHAVE LIKE EXTREMELY ROBUST SELF-SUPPORTING STRUCTURES WHICH ARE ABLE TO WITHSTAND CONSIDERABLE LOADS







acabados
finishes |



| acabados | *finishes*



COLOR ALUMINIO | ALUMINIUM COLOUR



ACABADO EN MADERA | WOODEN FINISH

EL MARCO DE SOSTENIBILIDAD DE OFITA

Ofita vincula su actividad empresarial al compromiso con el desarrollo sostenible.

El motor de su sistema de gestión es el modelo de excelencia EFQM (European Foundation for Quality Management), y da respuesta a los certificados más exigentes en materia de Calidad, Seguridad y Salud en el Trabajo y Medio Ambiente.

OFITA'S SUSTAINABILITY MODEL

Ofita links its business activity with sustainable development.

The driving force for its management system is the EFQM (European Foundation for Quality Management) model and it complies with the most demanding certificates in terms of Quality, Occupational Health and Safety and the Environment.

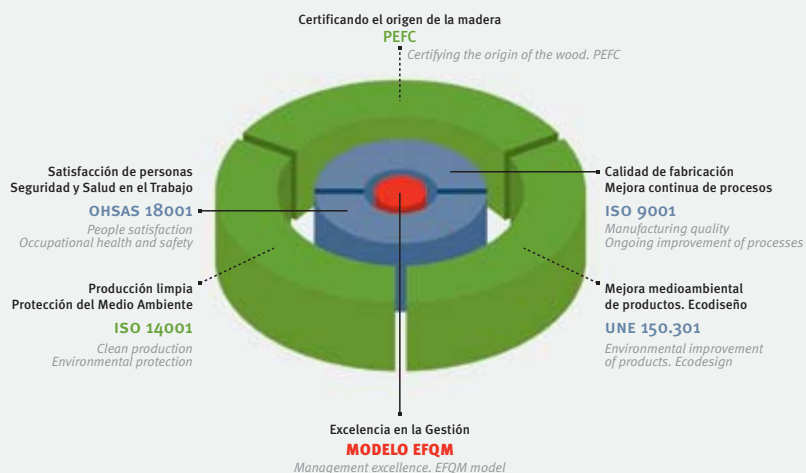

TAPIZADO | UPHOLSTERY

frente tapizado ▶

(disponible en una amplia variedad de colores)

upholstered front
(available in a wide range of colours)



POLIURETANO INTEGRAL | INTEGRAL POLYURETHANE

asiento don cojín en poliuretano ▶ integral color negro

seat with cushion in black
integral polyurethane







accessorios
accessories |



| **brazos** | *armrests*





| BRAZOS EN ARMONÍA CON LAS FORMAS DE LA BANCADA. ACABADO EN POLIURETANO DE AGRADABLE TACTO

| ARMRESTS IN HARMONY WITH THE BENCH AESTHETICS. FINISH IN POLYURETHANE WITH A PLEASANT FEEL





| mesa | table





| LA INCORPORACIÓN DE MESAS LATERALES AMPLÍA LA FUNCIONALIDAD DE LA BANCADA

| THE INCORPORATION OF SIDE TABLES ADDS TO THE FUNCTIONALITY OF THE BENCH





| soporte a pared | *wall support*





| EL SOPORTE A PARED POTENCIA LA LIGEREZA ESTÉTICA DE LA BANCADA

| THE WALL SUPPORT OPTIMISES THE AESTHETIC LIGHTNESS OF THE BENCH





| **unión entre bancadas** | *link between benches*





| LA UNIÓN ENTRE BANCADAS
RESPETA LAS SUAVES LÍNEAS DE
SIRIMIRI

| THE LINKING PIECE BETWEEN
BENCHES RESPECTS THE GENTLE
LINES OF SIRIMIRI



I respaldo medio I

medium backrest

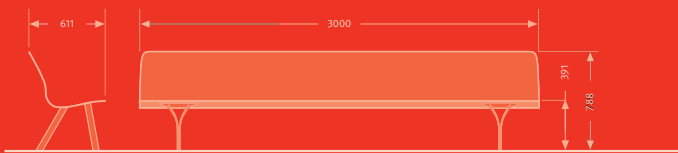
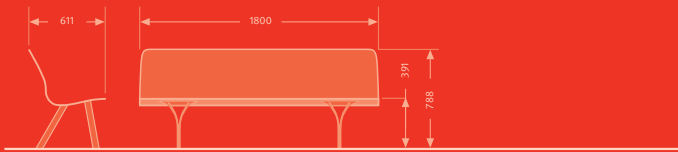
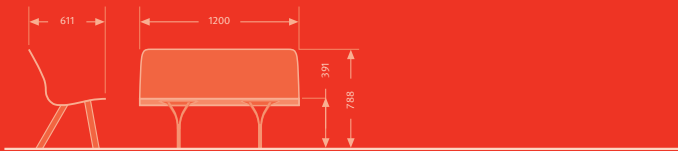

I respaldo alto I

high backrest

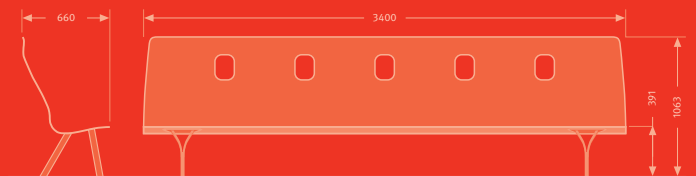
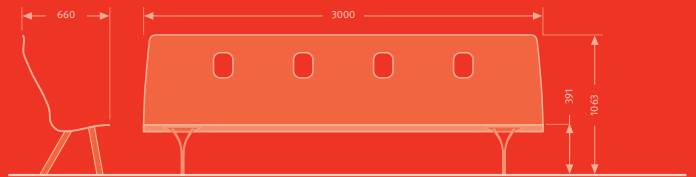
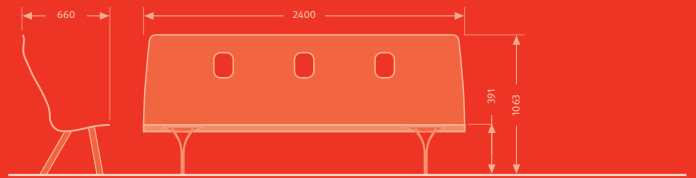
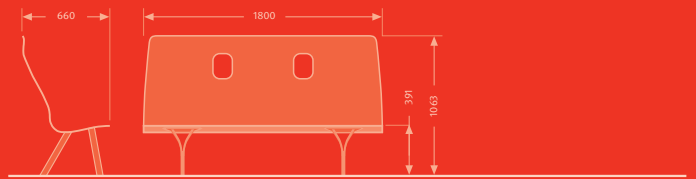
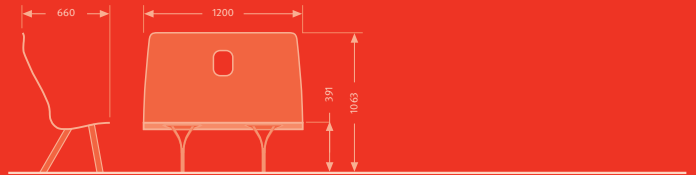

I accesorios I MESA

accessories I TABLE



I accesorios I MESA

accessories I TABLE



I accesorios I BRAZOS

accessories I ARMRESTS



I accesorios I BRAZOS

accessories I ARMRESTS

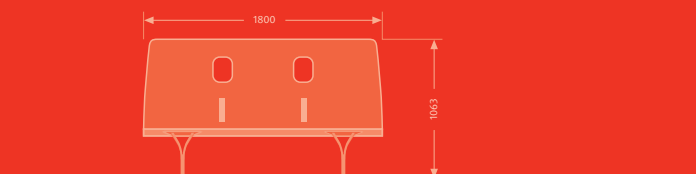

I sin respaldo I

without backrest

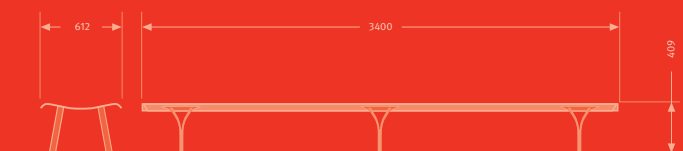
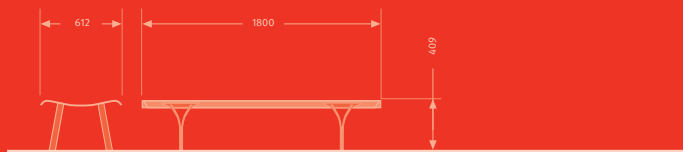
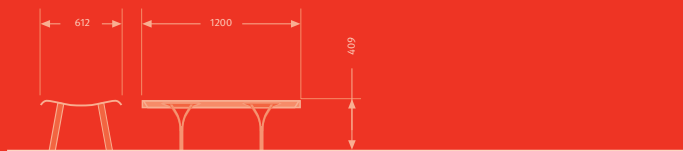

I SOPORTE A PARED I

WALL SUPPORT



I PIEZA DE UNIÓN I

LINKING PIECE



I accesorios I MESA I

accessories I TABLE



La serie **SIRIMIRI** ha sido diseñada reduciendo al máximo el impacto ambiental del producto en sus fases de producción, uso y desecho.
The **SIRIMIRI** series has been designed to minimise the environmental impact of the product during production, use and disposal.

Como resultado del compromiso de mejora continua de los productos OFITA, las especificaciones técnicas, equipamientos y fotografías de los productos, así como cualquier otra información aquí recogida en el catálogo, puede variar sin previo aviso.

As a result of OFITA's commitment to the concept of continuous improvement, technical specifications, equipment and photographs of products, as well as other information included in the catalogue, may vary without prior warning.