

Soluciones Visuales

VISUAL SOLUTIONS
SOLUTIONS VISUELLES



HOLA

BIENVENIDO AL NUEVO CATÁLOGO

WELCOME TO THE NEW CATALOGUE - BIENVENUE SUR LE NOUVEAU CATALOGUE

ESP. Bienvenido a este recorrido por las 6 familias de productos de Planning Sisplamo a través del nuevo catálogo general. Un catálogo reestructurado, ordenado y sobretodo útil. Tu herramienta de trabajo, otro año más a tu disposición.

ENG. Welcome to the new Planning Sisplamo general catalogue of products. Restructured, precise and above all useful. Your work tool, another year at your disposal.

FRA. Bienvenue sur le parcours de ce nouveau catalogue de produits de Planning Sisplamo Un catalogue restructuré, re-ordonné, et surtout utile. Votre outil de travail une nouvelle fois à votre disposition.

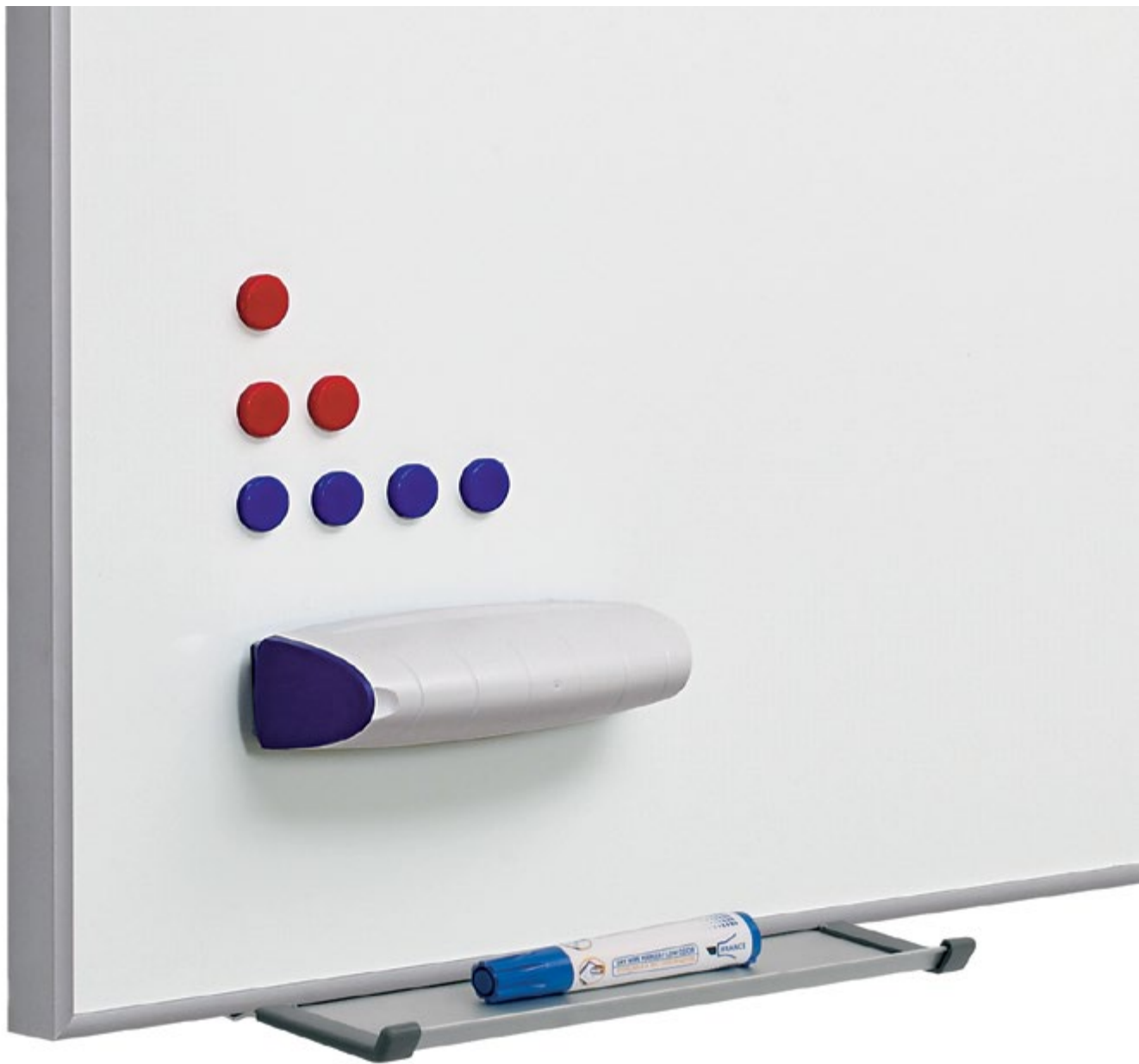



ÍNDICE

NUESTROS PRODUCTOS
OUR PRODUCTS - NOS PRODUITS

| | | |
|------------|-------------------|--------------|
| 01. | VISUALPLAN | PAG. 4-59 |
| 02. | ESCOLPLAN | PAG. 60-83 |
| 03. | INFORMPLAN | PAG. 84-105 |
| 04. | EXPOPLAN | PAG. 106-131 |
| 05. | MODULPLAN | PAG. 132-167 |
| 06. | ROTULPLAN | PAG. 168-189 |

VISUALPLAN

COMUNICACIÓN VISUAL
VISUAL COMMUNICATION
COMMUNICATION VISUELLE





SUPERFICIES PS

SUPERFICIES DE ESCRITURA
WRITTING SURFACES - SURFACE D'ÉCRITURE

SUPERFÍCIE DE CRISTAL

GLASS SURFACE - TABLEAU EN VERRE



ESP. Cristal pintado en blanco de 4 mm de grosor, unido con una chapa de 0,8 mm de hierro galvanizado magnética. Fácil mantenimiento y borrado gracias a la baja porosidad del material. Resistente a la abrasión, productos químicos, fuego, bacterias y graffitis.

ENG. Glass painted in white 4 mm thick with a 0.8 mm sheet of galvanized iron. Magnetic. Easy maintenance and erasure because of the low porosity of the material. Resistant to graze, chemicals, fire, bacteria and graffiti.

FRA. Verre peint en blanc de 4 mm d'épaisseur uni à une tôle en fer galvanisé de 0,8mm. Magnétique, Facile d'entretien grâce à une faible superficie poreuse. Résistante à l'abrasion, produits chimiques, feu, bactéries et graffitis.



728/M - 728/MC - 728 - 728/CO

SUPERFÍCIE LACADA

LACQUERED SURFACE - SURFACE LAQUÉE



ESP. Superficie blanca magnética de chapa metálica lacada cocida a más de 100°C. Incluye chapa de aluminio para mayor resistencia. Fácil mantenimiento.

ENG. Magnetic white surface of lacquered metal sheet heated to more than 100°C. Includes aluminum foil for added strength. Easy maintenance.

FRA. Superficie blanche magnétique grâce à une tôle métallique laquée cuite à plus de 100°C. Inclus renfort en aluminium pour une plus grande résistance. Facile d'entretien.

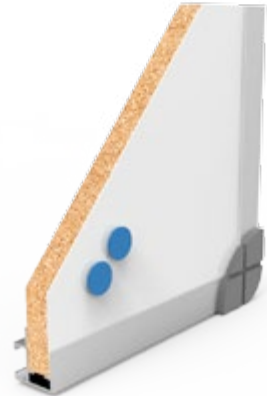

BL/VI - 722 - 724/LC - FLIPCHARTS - 1000

SUPERFÍCIE LAMINADA

LAMINATED SURFACE - SURFACE STRATIFIÉE



ESP. Superficie de escritura blanca en plancha laminada de alta presión (HPL). Extremadamente resistente a los impactos y desgaste. Fácil mantenimiento. No magnética.

ENG. White writing surface in high pressure laminated board (HPL). Extremely resistant to impacts and usage. Easy maintenance. Not magnetic.

FRA. Superficie d'écriture blanche en planche laminée à haute pression (HPL). Extrêmement résistante aux impacts et usure. Facile d'entretien. Non magnétique.



725 - 725/X



SUPERFICIE DE **ACERO VITRIFICADO** ENAMELLED SURFACE - SURFACE ÉMAILLÉE



ESP. Superficie blanca en acero vitrificado formada por una lámina central de acero de 0,7 mm cubierta con un revestimiento delgado de esmalte, que se funde con el acero a 800°C. Fabricado con un 30% de acero reciclado. Reciclable al 99,9%. Garantía de por vida. Resistente a rayaduras, abrasión, productos químicos, fuego, bacterias y graffitis. Fácil mantenimiento. Mayor contraste de color. Visibilidad mejorada y óptima comodidad visual. Magnética.

ENG. White surface in vitrified steel formed by a 0.7 mm steel core sheet covered with a thin coating of enamel, which melts with the steel at 800 ° C. Made with 30% recycled steel. Recyclable at 99.9%. Lifetime warranty. Resistant to scratches, abrasion, chemicals, fire, bacteria and graffiti. Easy maintenance. Higher color contrast. Improved visibility and optimum visual comfort. Magnetic.

FRA. Superficie blanc en acier vitrifié formé par une tôle d'acier de 0,7mm recouverte d'un revêtement émaillé fondu à 800°C. Fabriqué avec 30% d'acier recyclé. Recyclable à 99,9%. Garantie à vie. Résistant aux rayures, abrasion, produits chimiques, feu, bactéries et graffitis. Facile d'entretien. Grand contraste de couleur. Visibilité améliorée et qualité visuel optimum. Magnétique.

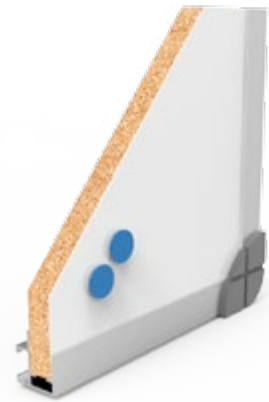

720 - 720/C - 720/P - 724 - ZENIT - 720/D
720/T - 720/X - 720/2/MV - 720/2/G - LEAN
CHAMELEON

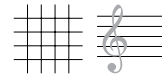

La superficie e3 CeramicSteel es la única del sector a nivel mundial con la certificación:

Cradle to Cradle Certified TM Bronze

Norma ISO 9001

PERFIL DE LA SUPERFICIE SURFACES PROFILE - PROFIL DE SURFACE

ESP. Los perfiles que enmarcan las pizarras de Planning Sisplamo son de aluminio anodizado. Las cantoneras, que ocultan el tornillo, son piezas fabricadas por inyección de ABS.

ENG. The profiles framing Planning Sisplamo white boards are anodized aluminum. The corners, which conceal the screw, are manufactured by injection ABS.

FRA. Les profiles qui encadrent les tableaux Planning Sisplamo sont en aluminium anodisé. Les coins, qui cachent la fixation, sont des pièces fabriquée par injection d'ABS.

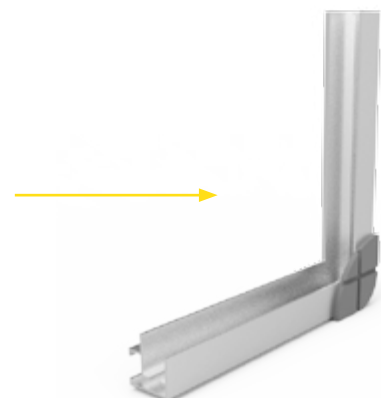

GUÍA PS

ESCOGE TU PIZARRA
CHOOSE YOUR WHITEBOARD - CHOISIR VOTRE TABLEAU



PERSONAL PERSONAL - PERSONALE

ESP. Pizarras de uso personal para el uso en el hogar o en salas de pequeñas dimensiones. Disponibles en versión mural, con soportes, en diferentes materiales y colores.

ENG. Whiteboards for use in the home or in small rooms. Available in mural version, with supports, in varied materials and many colors.

FRA. Tableau à usage personnel pour la maison ou de petites pièces/bureaux.. Disponible en version murale, avec support et en différents matériaux et couleurs.

- **BASIC**
- **722**
- ZENIT
- 728
- **728/CO**
- CHAMELEON
- FLIPCHARTS

BUSINESS BUSINESS - NEGOTIATIONS

ESP. Pizarras para uso en salas de reuniones o aulas de estudiantes reducidas. Disponibles en versión mural, con soporte y en diferentes materiales.

ENG. Whiteboards for use in meeting rooms or small classrooms. Available wall version, with supports, and in different materials.

FRA. Tableaux pour usage en salles de réunions et petites salles de classe. Disponibles en version murale, avec supports et en différents matériaux.

- 720
- 725
- **724**
- **ZENIT**
- 728/M
- 728/MC
- 728
- 728/CO
- 720/X
- 725/X
- **CHAMELEON**
- LEAN
- 1000

ESCUELA SCHOOL - ÉCOLE

ESP. Pizarras para el uso en aulas de mayor dimensión para más estudiantes. Disponibles en versión mural y en diferentes materiales.

ENG. Whiteboards for use in larger classrooms for more students. Available mural version and different materials.

FRA. Tableaux pour usage en salle de grande dimension pour plus d'étudiants. Disponible en version murale et en différents matériaux.

- **720**
- **720/C**
- **720/P**
- ZENIT
- RAIL
- 720/D
- 720/T
- **CHAMELEON**
- FLIPCHARTS
- **720/VV**
- **720/G**





1.

ESP Selecciona el perfil en el cual clasificarás tu captura.

ENG Select the profile in which you will classify your.

FRA Sélectionnez le profil dans lequel vous organiserez vos captures.



2.

ESP Encaja el contenido de la pizarra a la pantalla de tu smartphone. Espera a que dispere o dispara tú mismo.

ENG Embed the content of the whiteboard to the screen of your smartphone. Wait for automatic image or take picture yourself.

FRA Réajustez le contenu du tableau à l'écran de votre smartphone. Attendez la capture automatique ou faites-le manuellement.



3.

ESP Clasifica la imagen por etiquetas según asignaturas o temas.

ENG Sort the image using tags according to subjects.

FRA Ordonnez vos images par étiquettes suivant la matière ou le thème.



4.

ESP Comparte tus notas, apuntes o fotos con quien quieras a través mail, whatsapp u otras aplicaciones.

ENG Share your notes or photos with whoever you want via mail, whatsapp or other applications.

FRA Partagez vos notes, vos croquis ou photos avec qui vous le souhaitez par email, sms ou autres app.



PS Capture

by Planning Sisplamo

Capta, clasifica y comparte el contenido de tu pizarra.
Capture, classify and share the content of your board.
Capturez, ordenez et partagez le contenu de votre tableau.



planningsisplamo.com/pscapture

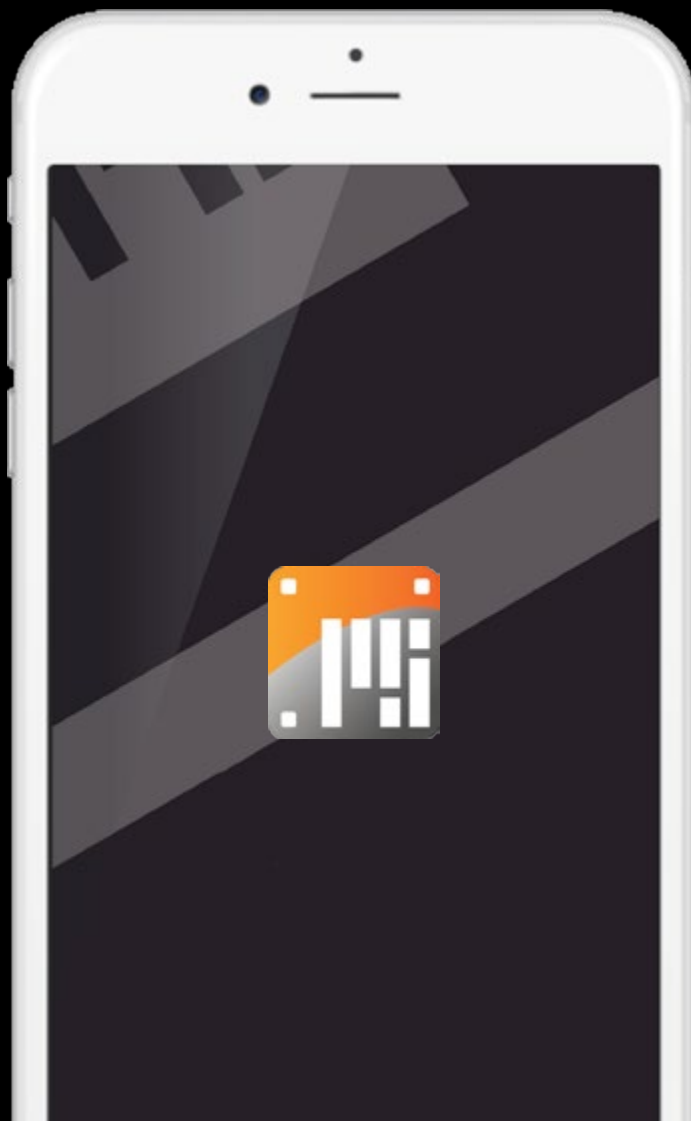

BASIC

PIZARRA LACADA
LACQUERED WHITEBOARD - TABLEAU LAQUÉ



| REF | L | H | W |
|------------|-----------|---|----|
| BL/VI/0010 | 45 x 60 | 1 | 30 |
| BL/VI/0011 | 60 x 90 | 1 | 30 |
| BL/VI/0012 | 90 x 120 | 1 | 30 |
| BL/VI/0013 | 100 x 150 | 1 | 30 |

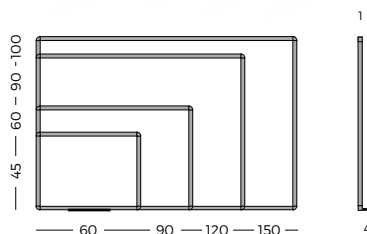

PIZARRA BASIC

ESP. Pizarra Basic lacada blanca. Enmarcada con perfil de aluminio anodizado en color plata mate y cantoneras redondeadas de plástico gris. Rotulable en seco. Magnética. Incluye cajetín reposarrotuladores de 30 cm.

BASIC WHITEBOARD

ENG. Basic lacquered whiteboard. Equipped with silver anodized aluminium frame and grey plastic rounded corners. Suitable for writing with dry wipe board markers. Magnetic. A 30 cm. pen tray included.

TABLEAU BASIC

FRA. Tableau Basic laqué blanc. Encadrement en aluminium anodisé couleur argent aux coins arrondis en plastique gris. Effaçable à sec. Magnétique. Livré avec un auget porte marqueurs de 30 cm.



722

PIZARRA LACADA
LACQUERED WHITEBOARD - TABLEAU LAQUÉ

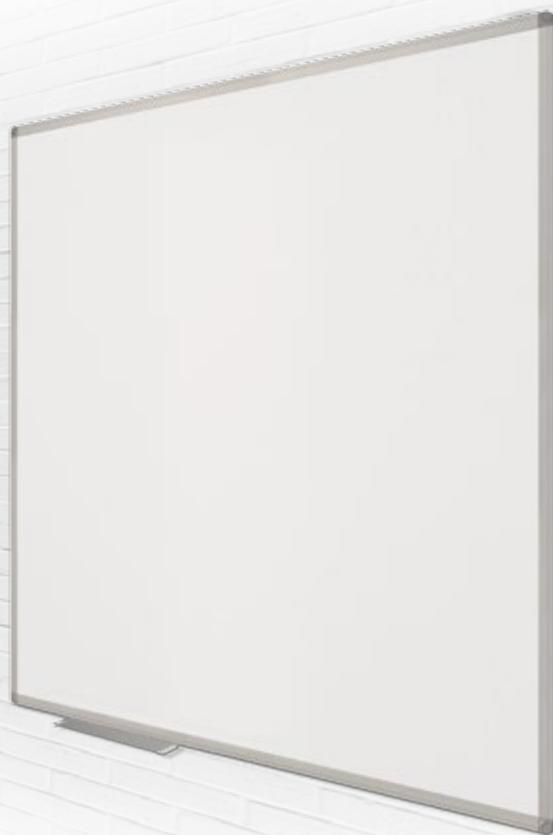

| REF | L | H | RAIL | RAIL |
|--------------|-----------|-----|------|------|
| 722/1 | 45 x 60 | 2,2 | 30 | - |
| 722/2 | 60 x 90 | 2,2 | 30 | ✓ |
| 722/3 | 90 x 120 | 2,2 | 30 | ✓ |
| 722/5 | 100 x 150 | 2,2 | 30 | ✓ |
| 722/6 | 100 x 200 | 2,2 | 30 | - |
| 722/7 | 100 x 250 | 2,2 | 30 | - |

Disponibles + soporte T

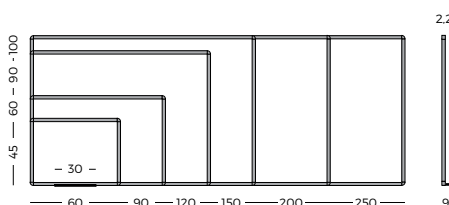

PIZARRA LACADA

ESP. Pizarra mural lacada blanca. Enmarcada con perfil de aluminio anodizado en color plata mate y cantoneras redondeadas de plástico gris. Rotulable en seco. Magnética. Incluye cajetín reposarrotuladores de 30 cm.

LACQUERED WHITEBOARD

ENG. Lacquered whiteboard. Equipped with silver anodized aluminium frame and grey plastic rounded corners. Suitable for writing with dry wipe board markers. Magnetic. 30 cm. pen tray included.

TABLEAU LAQUÉ

FRA. Tableau laqué blanc. Encadrement en aluminium anodisé couleur argent aux coins arrondis en plastique gris. Effaçable à sec. Magnétique. Livré avec auget porte marqueurs 30 cm.

725

PIZARRA LAMINADA
LAMINATED WHITEBOARD - TABLEAU STRATIFIÉ



| REF | L | H | RAIL |
|-------|-----------|-----|------|
| 725/1 | 40 x 60 | 2.2 | 30 - |
| 725/2 | 60 x 80 | 2.2 | 30 - |
| 725/3 | 80 x 120 | 2.2 | 30 ✓ |
| 725/4 | 100 x 120 | 2.2 | 30 ✓ |
| 725/5 | 120 x 150 | 2.2 | 30 ✓ |
| 725/6 | 120 x 175 | 2.2 | 30 ✓ |
| 725/7 | 120 x 200 | 2.2 | 30 - |
| 725/8 | 120 x 250 | 2.2 | 30 - |
| 725/9 | 120 x 300 | 2.2 | 30 - |



| REF | L | H | RAIL |
|---------|-----------|-----|------|
| 725/5/M | 120 x 150 | 2.2 | 30 ✓ |
| 725/7/M | 120 x 200 | 2.2 | 30 - |
| 725/8/M | 120 x 250 | 2.2 | 30 - |

Solo para proyección - No rotulable
Only for projection - Not for writing
Uniquement par projection - Pas pour écrire

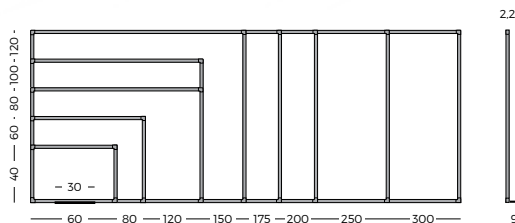

PIZARRA LAMINADA

ESP. Pizarra laminada blanca. Superficie laminada en alta presión. Enmarcada con perfil de aluminio anodizado en color plata mate y cantoneras redondeadas de plástico gris. Rotulable en seco. Incluye cajetín reposarrotuladores de 30 cm.

LAMINATED WHITEBOARD

ENG. High-pressure laminated whiteboard. Equipped with silver anodized aluminium frame and grey plastic rounded corners. Suitable for writing with dry wipe board markers. A 30 cm. pen tray included.

TABLEAU STRATIFIÉ

FRA. Tableau stratifié blanc. Encadrement en aluminium anodisé couleur argent aux coins arrondis en plastique gris. Surface effaçable à sec. Livré avec un auget porte marqueurs de 30 cm.



SOPORTE T

| REF | ↑ | L | ⊥ | □ |
|--------------|-----|-----------|----|----|
| 705/L | 190 | 100 x 80 | 53 | 30 |
| 706/L | 190 | 100 x 120 | 53 | 30 |
| 713/L | 190 | 120 x 150 | 53 | 30 |
| 714/L | 190 | 120 x 200 | 53 | 30 |



SOPORTE DELTA

| REF | ↑ | L | ⊥ | □ |
|--------------|-----|-----------|----|----|
| 707/L | 190 | 100 x 80 | 53 | 30 |
| 708/L | 190 | 100 x 120 | 53 | 30 |
| 715/L | 190 | 120 x 150 | 53 | 30 |
| 716/L | 190 | 120 x 200 | 53 | 30 |



SOPORTE Y2

| REF | ↑ | L | ⊥ | □ |
|-----------------|-----|-----------|----|----|
| + Y2/80 | 190 | 80 x 100 | 53 | 30 |
| + Y2/120 | 190 | 100 x 120 | 53 | 30 |
| + Y2/150 | 190 | 120 x 150 | 53 | 30 |
| + Y2/175 | 190 | 120 x 175 | 53 | 30 |
| + Y2/200 | 190 | 120 x 200 | 53 | 30 |

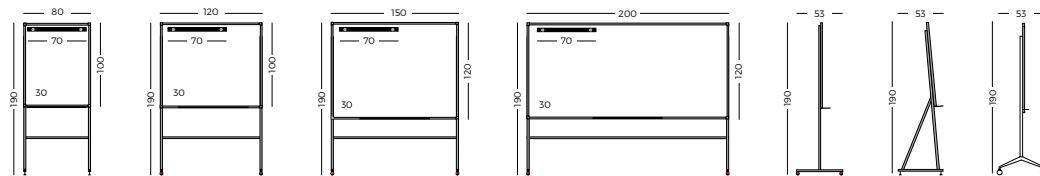

PS Capture
 App by Planning Sislamo
www.planningsislamo.com/pscapture



ACCESORIOS

7012



7014



7008



720

PIZARRA DE ACERO VITRIFICADO
ENAMELLED WHITEBOARD - TABLEAU ÉMAILLÉ



| REF | L | H | RAIL |
|---------------|-----------|-----|------|
| 720/10 | 40 x 60 | 2.2 | 30 - |
| 720/1 | 60 x 80 | 2.2 | 30 - |
| 720/2 | 80 x 100 | 2.2 | 30 ✓ |
| 720/3 | 100 x 120 | 2.2 | 30 ✓ |
| 720/4 | 100 x 150 | 2.2 | 30 ✓ |
| 720/5 | 100 x 175 | 2.2 | 30 ✓ |
| 720/6 | 120 x 200 | 2.2 | 30 - |
| 720/7 | 120 x 250 | 2.2 | 30 - |
| 720/8 | 120 x 300 | 2.2 | 30 - |
| 720/9 | 120 x 400 | 2.2 | 30 - |
| 720/15 | 150 x 300 | 2.2 | 30 - |

| REF | L | H | RAIL |
|-----------------|-----------|-----|------|
| 720/4/M | 120 x 150 | 2.2 | 30 ✓ |
| 720/6/M | 120 x 200 | 2.2 | 30 - |
| 720/7/M | 120 x 250 | 2.2 | 30 - |
| 720/8/M | 120 x 300 | 2.2 | 30 - |
| 720/9/M | 120 x 400 | 2.2 | 30 - |
| 720/15/M | 150 x 300 | 2.2 | 30 - |

Para proyección
For projection
Par projection

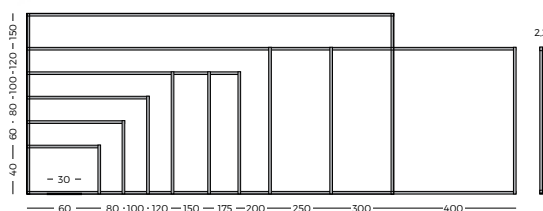

PIZARRA DE ACERO VITRIFICADO

ESP. Pizarra mural de acero vitrificado blanco. Enmarcada con perfil de aluminio anodizado en color plata mate. Superficie de acero vitrificado a 800°C con garantía de por vida. Rotulable en seco. Magnética. Incluye cajetín de 30 cm.

ENAMELLED WHITEBOARD

ENG. Enamelled whiteboard. Equipped with silver anodized aluminium frame and plastic rounded corners. Surface enamelled at 800°C. Suitable for writing with dry wipe board markers. Magnetic. 30 cm tray included. Lifetime warranty.

TABLEAU ÉMAILLÉ

FRA. Tableau émaillé blanc. Encadrement en aluminium anodisé couleur argent aux coins arrondis en plastique. Surface émaillée vitrifiée à 800°C. Livré avec auget porte marqueurs de 30 cm. Magnétique. Garantie à vie.



SOPORTE T

| REF | ↑ | L | ⊥ | □ |
|--------------|-----|-----------|----|----|
| 705/A | 190 | 100 x 80 | 53 | 30 |
| 706/A | 190 | 100 x 120 | 53 | 30 |
| 713/A | 190 | 100 x 150 | 53 | 30 |
| 714/A | 190 | 120 x 200 | 53 | 30 |



SOPORTE DELTA

| REF | ↑ | L | ⊥ | □ |
|--------------|-----|-----------|----|----|
| 707/A | 190 | 100 x 80 | 53 | 30 |
| 708/A | 190 | 100 x 120 | 53 | 30 |
| 715/A | 190 | 100 x 150 | 53 | 30 |
| 716/A | 190 | 120 x 200 | 53 | 30 |



SOPORTE Y2

| REF | ↑ | L | ⊥ | □ |
|-----------------|-----|-----------|----|----|
| + Y2/80 | 190 | 80 x 100 | 53 | 30 |
| + Y2/120 | 190 | 100 x 120 | 53 | 30 |
| + Y2/150 | 190 | 100 x 150 | 53 | 30 |
| + Y2/200 | 190 | 120 x 200 | 53 | 30 |

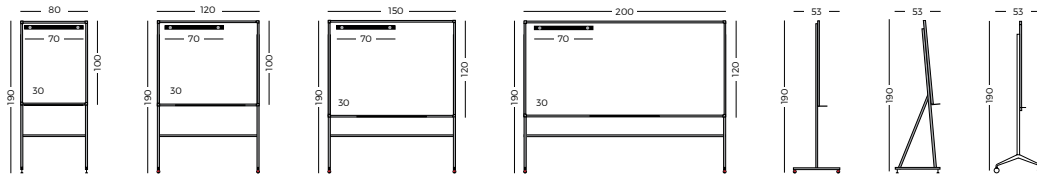

PS Capture
 App by Planning Sislamo
www.planningsislamo.com/pscapture



ACCESORIOS

7006



7019



9002



720/C-720/P

PIZARRA DE ACERO VITRIFICADO CON CUADRICULA/PENTAGRAMA
 GRID/PENTAGRAM - QUADRILLÉ/PENTAGRAMME

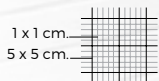
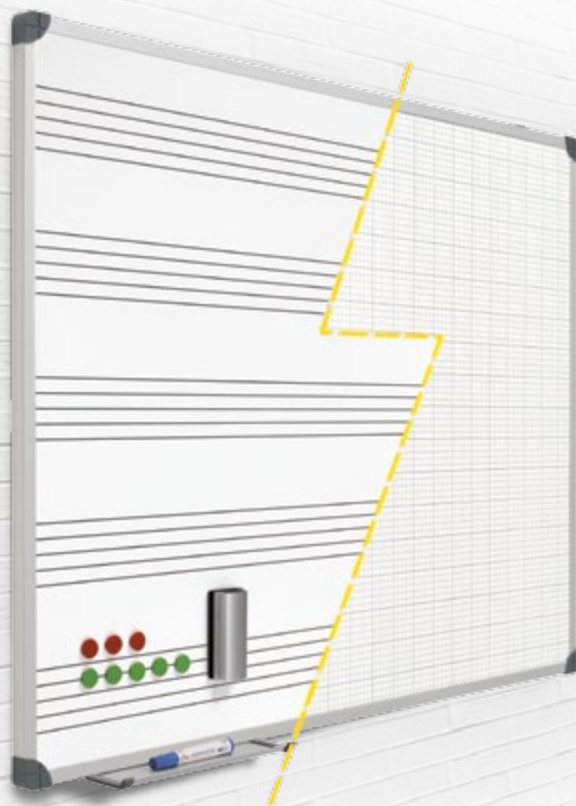
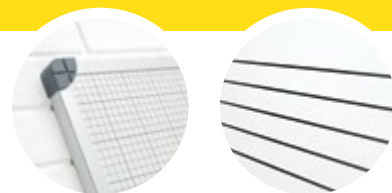

| REF | L | H | RAIL |
|--------|-----------|-----|------|
| 720/C1 | 45 x 60 | 2.2 | 30 - |
| 720/C2 | 60 x 90 | 2.2 | 30 - |
| 720/C3 | 90 x 120 | 2.2 | 30 ✓ |
| 720/C4 | 120 x 180 | 2.2 | 30 ✓ |

| REF | L | H | RAIL |
|--------|-----------|-----|------|
| 720/P1 | 120 x 150 | 2.2 | 30 ✓ |
| 720/P2 | 120 x 200 | 2.2 | 30 - |
| 720/P3 | 120 x 300 | 2.2 | 30 - |

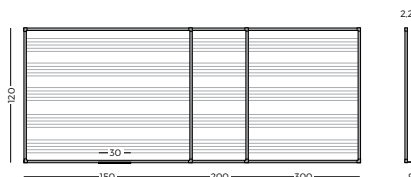
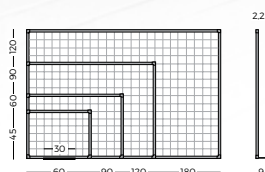

PIZARRA CUADRICULADA/PENTAGRAMA

ESP. Pizarra mural de acero vitrificado blanco con cuadrícula o pentagrama. Enmarcada con perfil de aluminio anodizado en color plata mate. Superficie de acero vitrificado a 800°C con garantía de por vida. Rotulable en seco. Magnética. Incluye cajetín de 30 cm.

GRIDED/PENTAGRAM WHITEBOARD

ENG. Enamelled grided or pentagram whiteboard. Equipped with silver anodized aluminium frame and plastic rounded corners. Surface enamelled at 800°C. Suitable for writing with dry wipe board markers. Magnetic. 30 cm tray included. Lifetime warranty.

TABLEAU QUADRILLÉ/PENTAGRAMME

FRA. Tableau émaillé blanc quadrillé ou pentagramme. Encadrement en aluminium anodisé couleur argent aux coins arrondis en plastique. Surface émaillée vitrifiée à 800°C. Livré avec auget porte marqueurs de 30 cm. Magnétique. Garantie à vie.



SOPORTE T

| REF | ↑ | L | ⊥ | □ |
|----------|-----|-----------|----|----|
| 720/C3/T | 190 | 90 x 120 | 53 | 30 |
| 720/C4/T | 190 | 120 x 180 | 53 | 30 |
| 720/P1/T | 190 | 120 x 150 | 53 | 30 |
| 720/P2/T | 190 | 120 x 200 | 53 | 30 |



SOPORTE DELTA

| REF | ↑ | L | ⊥ | □ |
|----------|-----|-----------|----|----|
| 720/C3/D | 190 | 90 x 120 | 53 | 30 |
| 720/C4/D | 190 | 120 x 180 | 53 | 30 |
| 720/P1/D | 190 | 120 x 150 | 53 | 30 |
| 720/P2/D | 190 | 120 x 200 | 53 | 30 |



SOPORTE Y2

| REF | ↑ | L | ⊥ | □ |
|----------|-----|-----------|----|----|
| + Y2/120 | 181 | 100 x 120 | 53 | 30 |
| + Y2/150 | 181 | 100 x 150 | 53 | 30 |
| + Y2/200 | 181 | 120 x 200 | 53 | 30 |

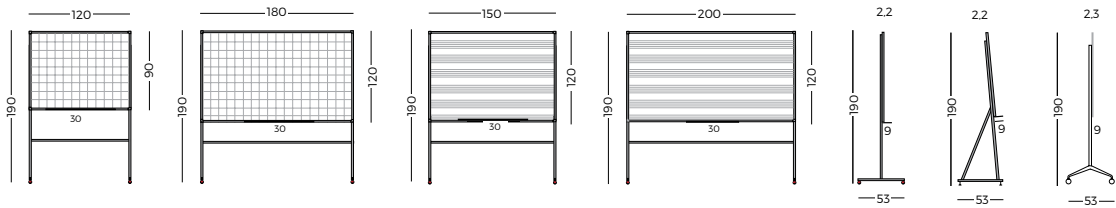

PS Capture
App by Planning Sisplamo
www.planningsisplamo.com/pscapture



ACCESORIOS

7006



7019



9002



724

PIZARRA DE ACERO VITRIFICADO CON MARCO 'MINI'
WHITEBOARD 'MINI' - TABLEAU 'MINI'



| REF | L | H | RAIL |
|--------|-----------|-----|------|
| 724/10 | 40 x 60 | 2.3 | 30 - |
| 724/1 | 60 x 80 | 2.3 | 30 - |
| 724/2 | 80 x 100 | 2.3 | 30 ✓ |
| 724/3 | 100 x 120 | 2.3 | 30 ✓ |
| 724/4 | 100 x 150 | 2.3 | 30 ✓ |
| 724/5 | 100 x 175 | 2.3 | 30 ✓ |
| 724/6 | 120 x 200 | 2.3 | 30 - |

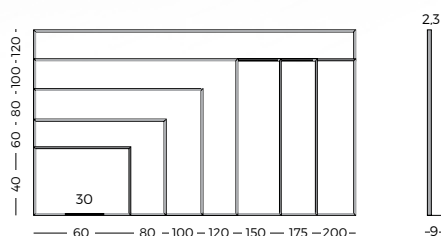

| REF | L | H | RAIL |
|-----------|-----------|-----|------|
| 724/10/LC | 45 x 60 | 2.3 | 30 - |
| 724/1/LC | 60 x 90 | 2.3 | 30 - |
| 724/2/LC | 80 x 100 | 2.3 | 30 ✓ |
| 724/3/LC | 90 x 120 | 2.3 | 30 ✓ |
| 724/4/LC | 100 x 150 | 2.3 | 30 ✓ |
| 724/5/LC | 100 x 175 | 2.3 | 30 ✓ |
| 724/6/LC | 100 x 200 | 2.3 | 30 - |



PIZARRA DE ACERO VITRIFICADO 'MINI'

ESP. Pizarra mural de acero vitrificado blanco. Enmarcada con perfil de aluminio anodizado Mini en color plata mate. Superficie de acero vitrificado a 800°C con garantía de por vida. Rotulable en seco. Magnética. Incluye cajetín de 30 cm.

ENAMELLED WHITEBOARD 'MINI'

ENG. Enamelled whiteboard. Equipped with Mini silver anodized aluminium frame and mitred corners. Surface enamelled at 800°C. Suitable for writing with dry wipe board markers. Magnetic. 30 cm tray included. Lifetime warranty.

TABLEAU ÉMAILLÉ 'MINI'

FRA. Tableau émaillé blanc. Encadrement Mini en aluminium anodisé couleur argent. Surface émaillée vitrifiée à 800°C. Livré avec auget porte marqueurs de 30 cm. Magnétique. Garantie à vie.



SORTE T

| REF | ↑ | L | ⊥ | □ |
|---------------|-----|-----------|----|----|
| 724/T2 | 190 | 100 x 80 | 53 | 30 |
| 724/T3 | 190 | 100 x 120 | 53 | 30 |
| 724/T4 | 190 | 100 x 150 | 53 | 30 |
| 724/T6 | 190 | 120 x 200 | 53 | 30 |



SORTE DELTA

| REF | ↑ | L | ⊥ | □ |
|---------------|-----|-----------|----|----|
| 724/D2 | 190 | 100 x 80 | 53 | 30 |
| 724/D3 | 190 | 100 x 120 | 53 | 30 |
| 724/D4 | 190 | 100 x 150 | 53 | 30 |
| 724/D6 | 190 | 120 x 200 | 53 | 30 |



SORTE Y2

| REF | ↑ | L | ⊥ | □ |
|---------------|-----|-----------|----|----|
| 724/Y2 | 181 | 100 x 80 | 53 | 30 |
| 724/Y3 | 181 | 100 x 120 | 53 | 30 |
| 724/Y4 | 181 | 100 x 150 | 53 | 30 |
| 724/Y6 | 181 | 120 x 200 | 53 | 30 |

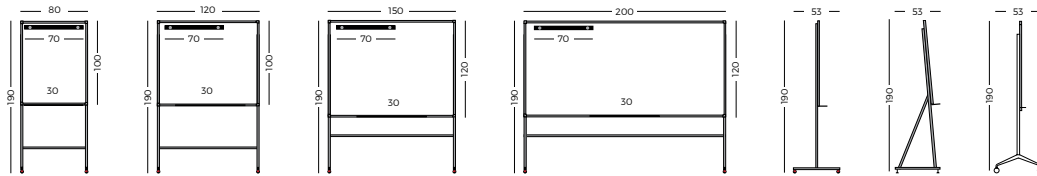

PS Capture
 App by Planning Sisplamo
www.planningsisplamo.com/pscapture



ACCESORIOS

7006



7019



9002



728/M

PIZARRA DE CRISTAL
GLASSBOARD - TABLEAU EN VERRE



| REF | L | H | ⊠ |
|--------|-----------|-----|----|
| 728/M1 | 60 x 80 | 2.3 | 30 |
| 728/M2 | 80 x 100 | 2.3 | 30 |
| 728/M3 | 100 x 120 | 2.3 | 30 |
| 728/M4 | 100 x 150 | 2.3 | 30 |
| 728/M5 | 100 x 175 | 2.3 | 30 |

| + T | + DELTA | + Y2 | | | | |
|----------|----------|----------|-----|-----------|----|----|
| REF | REF | REF | ↑ | L | H | ⊠ |
| 728/M2/T | 728/M2/D | 728/M2/Y | 190 | 80 x 100 | 53 | 30 |
| 728/M3/T | 728/M3/D | 728/M3/Y | 190 | 100 x 120 | 53 | 30 |
| 728/M4/T | 728/M4/D | 728/M4/Y | 190 | 100 x 150 | 53 | 30 |
| 728/M5/T | 728/M5/D | 728/M5/Y | 190 | 100 x 175 | 53 | 30 |

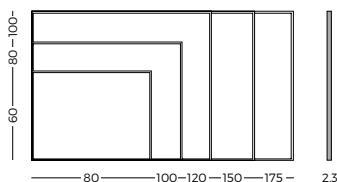

PIZARRA DE CRISTAL

ESP. Pizarra de cristal laminado translúcido. Enmarcada a inglete con perfil de aluminio anodizado "Mini" en color plata mate. Superficie magnética rotulable con rotuladores de borrado en seco. Incorpora elementos de fijación a pared y cajetín reposarotuladores.

GLASSBOARD

ENG. Translucent laminated glass board equipped with matt silver anodized "Mini" aluminium frame and mitred corners. Magnetic surface is suitable for writing with dry wipe board markers. Wall-mounted brackets and pen tray included.

TABLEAU EN VERRE

FRA. Tableau en verre laminé magnétique avec encadrement en aluminium anodisé "Mini" couleur argent. Surface pour feutre effaçables à sec, livré avec les éléments de fixation murale et un auget.



728/MC

PIZARRA DE CRISTAL DE COLORES
GLASSBOARD - TABLEAU EN VERRE



COLOR RAL



/AM /VD /RS /AZ /NJ /GR /MR
1016 6019 3015 7035 2012 9006 1011

Consultar para colores especiales.

| REF | L | H | ⊠ |
|----------------|-----------|-----|----|
| 728/MC1 | 60 x 80 | 2,3 | 30 |
| 728/MC2 | 80 x 100 | 2,3 | 30 |
| 728/MC3 | 100 x 120 | 2,3 | 30 |
| 728/MC4 | 100 x 150 | 2,3 | 30 |
| 728/MC5 | 100 x 175 | 2,3 | 30 |

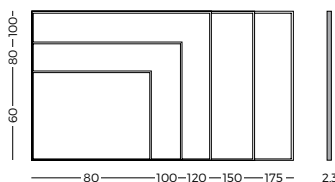

PIZARRA DE CRISTAL DE COLOR

ESP. Pizarra de cristal laminado de color enmarcada a inglete con perfil de aluminio anodizado "Mini" en color plata mate. Superficie magnética rotulable con rotuladores de borrado en seco. Incorpora elementos de fijación a pared y cajetín reposarotuladores.

COLOUR GLASSBOARD

ENG. Colour laminated glass board equipped with matt silver anodized "Mini" aluminium frame and mitred corners. Magnetic surface is suitable for writing with dry wipe board markers. Wall-mounted brackets and pen tray included.

TABLEAU EN VERRE DE COULEUR

FRA. Tableau en verre de couleur laminé magnétique vec encadrement en aluminium anodisé "Mini" couleur argent. Surface pour feutre effaçables à sec, livré avec les éléments de fixation murale et un auget.

728

PIZARRA DE CRISTAL
GLASSBOARD - TABLEAU EN VERRE



| REF | L | H |
|-------|-----------|-----|
| 728/1 | 45 x 60 | 0.3 |
| 728/2 | 60 x 90 | 0.3 |
| 728/3 | 90 x 120 | 0.3 |
| 728/4 | 100 x 150 | 0.3 |

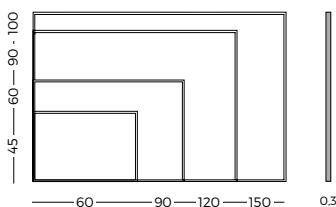

PIZARRA DE CRISTAL

ESP. Pizarra magnética de cristal traslúcido sin marco de 3 mm de grosor. Superficie rotulable con rotuladores de borrado en seco. Incorpora elementos de fijación a pared y cajetín reposarrotuladores de 30 cm. junto a borrador especial y 5 imanes de neodimio.

GLASSBOARD

ENG. Translucid 3 mm. thick magnetic glass board without frame. Surface is suitable for writing with dry wipe board markers. Wall-mounted brackets are included, as well as an eraser for glass surfaces, a 30 cm pen tray and 5 neodymium magnets

TABLEAU EN VERRE

FRA. Tableau en verre magnétique sans profil de 3 mm d'épaisseur. surface pour feutre effaçables à sec, livré avec les éléments de fixation murale et auget, ainsi qu'un effaceur, un porte-marqueur de 30 cm et 5 aimants.



728/CO

PIZARRA DE CRISTAL DE COLORES
COLOUR GLASSBOARD - TABLEAU EN VERRE DE COULEUR



COLOR RAL



/AM /VD /RS /AZ /NJ /GR /MR
1016 6019 3015 7035 2012 9006 1011

Consultar para colores especiales.

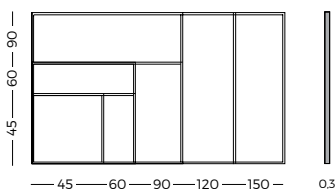

| REF | L | H |
|-----------------|----------|-----|
| 728/CO/1 | 45 x 45 | 0.3 |
| 728/CO/2 | 45 x 60 | 0.3 |
| 728/CO/3 | 45 x 90 | 0.3 |
| 728/CO/4 | 60 x 60 | 0.3 |
| 728/CO/5 | 60 x 90 | 0.3 |
| 728/CO/6 | 90 x 90 | 0.3 |
| 728/CO/7 | 90 x 120 | 0.3 |
| 728/CO/8 | 90 x 150 | 0.3 |

728/CO/A Kit de accesorios



PIZARRA DE CRISTAL DE COLOR

ESP. Pizarra magnética de cristal de colores sin marco de 3 mm de grosor. Superficie rotulable con rotuladores de borrado en seco. Incorpora elementos de fijación a pared. Kit de accesorios disponible: borrador para superficie de cristal y 5 imanes de neodimio.

COLOUR GLASSBOARD

ENG. Colour 3 mm thick magnetic glass board without frame. Surface is suitable for writing with dry wipe board markers. Wall-mounted brackets are included. Accessories available: eraser and 5 neodymium magnets.

TABLEAU EN VERRE DE COULEUR

FRA. Tableau en verre de couleur magnétique sans profil de 3 mm d'épaisseur. surface pour feutre effaçables à sec, livré avec les éléments de fixation murale. Accessoires disponibles: effaceur et 5 aimants.

ZENIT

PIZARRA ZENIT DE ACERO VITRIFICADO/LAMINADA
ENAMELLED/LAMINATED WHITEBOARD - TABLEAU ÉMAILLÉ/STRATIFIÉ



| REF | L | H | RAIL |
|---------|-----------|-----|------|
| Z/720/1 | 60 x 80 | 2.3 | 30 - |
| Z/720/2 | 80 x 100 | 2.3 | 30 ✓ |
| Z/720/3 | 100 x 120 | 2.3 | 30 ✓ |
| Z/720/4 | 100 x 150 | 2.3 | 30 ✓ |
| Z/720/5 | 100 x 175 | 2.3 | 30 ✓ |
| Z/720/6 | 120 x 200 | 2.3 | 30 - |
| Z/720/7 | 120 x 250 | 2.3 | 30 - |



| REF | L | H | RAIL |
|---------|-----------|-----|------|
| Z/725/1 | 60 x 80 | 2.3 | 30 - |
| Z/725/2 | 80 x 100 | 2.3 | 30 ✓ |
| Z/725/3 | 100 x 120 | 2.3 | 30 ✓ |
| Z/725/4 | 120 x 150 | 2.3 | 30 ✓ |
| Z/725/5 | 120 x 175 | 2.3 | 30 v |
| Z/725/6 | 120 x 200 | 2.3 | 30 - |
| Z/725/7 | 120 x 250 | 2.3 | 30 - |

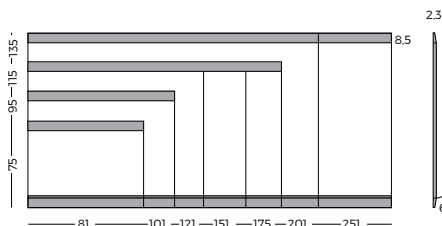

PIZARRA ZENIT

ESP. Pizarra mural Zenit de acero vitrificado o laminada blanca. Enmarcada con perfil de aluminio anodizado en color plata mate. Superficie de acero vitrificado a 800°C con garantía de por vida. Rotulable en seco. Magnética. Incluye cajetín de 30 cm.

ZENIT WHITEBOARD

ENG. Enamelled/laminated Zenit whiteboard. Equipped with silver anodized aluminium frame and plastic rounded corners. Surface enamelled at 800°C. Suitable for writing with dry wipe board markers. Magnetic. 30 cm tray included. Lifetime warranty.

TABLEAU ZENIT

FRA. Tableau en acier émaillé ou stratiifié blanc. Encadrement en aluminium anodisé couleur argent aux coins arrondis en plastique. Surface émaillée vitrifiée à 800°C. Livré avec auget porte marqueurs de 30 cm. Magnétique. Garantie à vie.



CUADRÍCULA

| REF | L | H | AV |
|----------|-----------|-----|----|
| Z/720/C1 | 45 x 60 | 2,3 | 30 |
| Z/720/C2 | 60 x 90 | 2,3 | 30 |
| Z/720/C3 | 90 x 120 | 2,3 | 30 |
| Z/720/C4 | 120 x 180 | 2,3 | 30 |



PENTAGRAMA

| REF | L | H | AV |
|----------|-----------|-----|----|
| Z/720/P1 | 120 x 150 | 2,3 | 30 |
| Z/720/P2 | 120 x 200 | 2,3 | 30 |
| Z/720/P3 | 120 x 300 | 2,3 | 30 |



SOPORTE Y2

| REF | L | H | AV |
|----------|-----|-----------|-------|
| Z/720/Y2 | 190 | 100 x 80 | 53 30 |
| Z/720/Y3 | 190 | 100 x 120 | 53 30 |
| Z/720/Y4 | 190 | 100 x 150 | 53 30 |
| Z/720/Y6 | 190 | 120 x 200 | 53 30 |

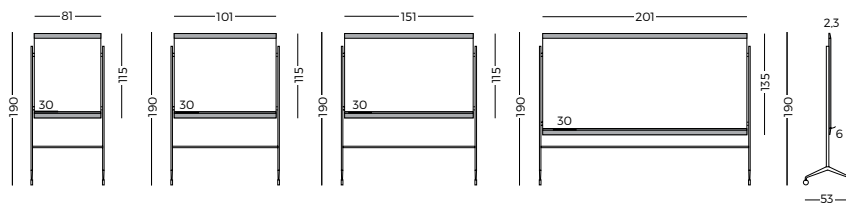

PS Capture
App by Planning Sisplamo
www.planningsisplamo.com/pscapture



ACCESORIOS

7006



7019



9002



RAIL

SISTEMA DE RAIL
RAIL SYSTEM - SYSTÈME RAIL

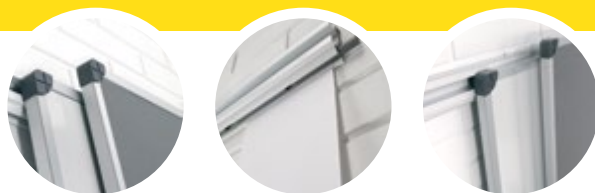

| REF | ↑ | ⇄ |
|--------|-----|---|
| RP/000 | - | 8 |
| RP/100 | 100 | 8 |
| RP/200 | 200 | 8 |
| RP/300 | 300 | 8 |

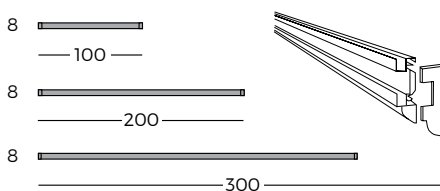

SISTEMA DE RAIL

ESP. Rail plan es el sistema que mediante un perfil de aluminio lacado blanco, fijado a la pared, permite colgar en sus dos carriles, pizarras, tableros, etc.... desplazarlos longitudinalmente y hacer posible cualquier tipo de presentación, etc.

RAIL SYSTEM

ENG. Rail's Plan lacquered aluminium profile fixed on a wall allows you to hang all types of boards and move them horizontally to help with your presentations and exhibitions. Below the lower rail you will find fittings suitable for hanging note pads, etc.

SYSTÈME RAIL

FRA. Système de rail en aluminium en fixation murale pour superposer et faire coulisser des tableaux sur deux hauteurs de rail, idéal pour les présentations dans le bureau ou en salle de cours. Les documents seront soutenus par pression sous le rail.



PIZARRA 720 - 725

pag. 14

| REF | L | H | W | D |
|--------------|-----------|---|----|---|
| 720/2 | 80 x 100 | 6 | 30 | |
| 720/3 | 100 x 120 | 6 | 30 | |
| 720/4 | 100 x 150 | 6 | 30 | |
| 720/5 | 100 x 175 | 6 | 30 | |
| 725/3 | 80 x 100 | 6 | 30 | |
| 725/4 | 100 x 120 | 6 | 30 | |
| 725/5 | 100 x 150 | 6 | 30 | |
| 725/6 | 120 x 175 | 6 | 30 | |



PIZARRA ZENIT

pag. 26

| REF | L | H | W | D |
|----------------|-----------|---|----|---|
| Z/720/2 | 80 x 100 | 6 | 30 | |
| Z/720/3 | 100 x 120 | 6 | 30 | |
| Z/720/4 | 100 x 150 | 6 | 30 | |
| Z/720/5 | 100 x 175 | 6 | 30 | |



TABLERO 760 - 765

pag. 86

| REF | L | H | W | D |
|--------------|-----------|-----|---|---|
| 760/2 | 80 x 100 | 2,2 | - | |
| 760/3 | 100 x 120 | 2,2 | - | |
| 760/4 | 100 x 150 | 2,2 | - | |
| 760/5 | 100 x 175 | 2,2 | - | |
| 765/2 | 80 x 100 | 2,2 | - | |
| 765/3 | 100 x 120 | 2,2 | - | |
| 765/4 | 100 x 150 | 2,2 | - | |
| 765/5 | 120 x 175 | 2,2 | - | |

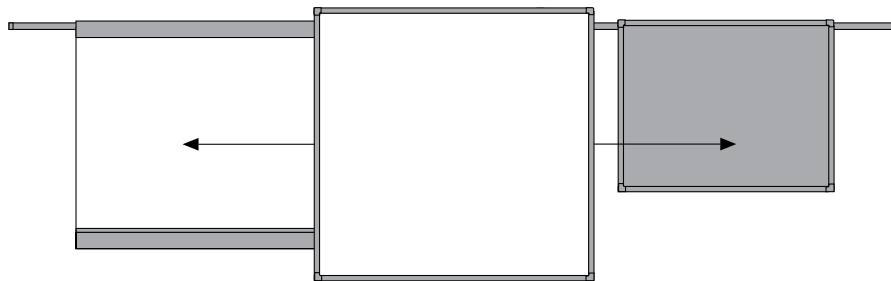

ACCESORIOS PARA RAIL

RP/30

| | |
|-----|---|
| | |
| 2,5 | 5 |



RP/L

| | |
|-------|-----|
| | |
| 5 x 8 | 90° |

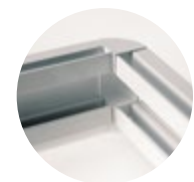

SUPPORTS

SOPORTES DE PIÉ
FLOOR SUPPORTS - PIÉTEMENTS



| REF | ↑ | → | max |
|-------------------|-----|----|-----|
| Y2/80/R Y2/80/N | 173 | 53 | 80 |
| Y2/120/R Y2/120/N | 173 | 53 | 120 |
| Y2/150/R Y2/150/N | 173 | 53 | 150 |
| Y2/175/R Y2/175/N | 173 | 53 | 175 |
| Y2/200/R Y2/200/N | 173 | 53 | 200 |



770/1 174 53 120 x 200

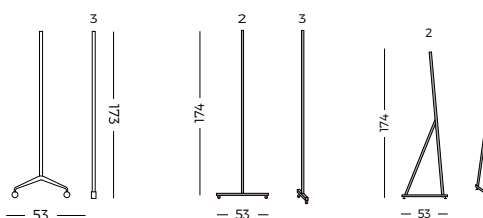

| REF | ↑ | → | max |
|--------------|-----|----|-----------|
| 770/2 | 174 | 53 | 120 x 200 |



SOPORTES

ESP. "Y2": Juego de soportes, fabricados en perfil de aluminio y pié de fundición. Incorpora ruedas con freno o niveladores. "T" + Delta: Juego de soportes metálicos, para adaptar pizarras, tableros, etc. Uso aconsejable hasta 2 metros de largo.

SUPPORTS

ENG. "Y2" Set of 2 aluminium and cast-iron supports with castors or jacks for whiteboard. Suitable for all showcases, boards and panels. "T" support with 4 castors (2 of them with brakes). Recommended for lengths of up to 2 meters.

PIÉTEMENTS

FRA. "Y2" Jeu de 2 piétements métalliques en aluminium et fonte. Livré avec roulettes (munies de freins). "T" + Delta : jeu de support métalliques pour adapter tableaux, vitrines... Taille recommandée du support jusqu'à 2m de large.



| REF | ↓ | → | max |
|-------|-----|----|----------|
| 770/6 | 190 | 70 | 120 x 90 |



| REF | ↓ | → | max |
|-------|-----|----|-----------|
| 770/5 | 160 | 90 | 100 x 120 |

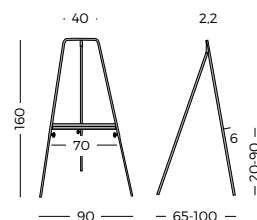
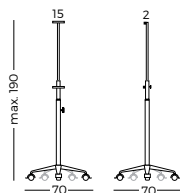

SOPORTES

ESP. Soporte para tableros y pizarras fabricado con tubo metálico. Regulable en altura. La Ref. 770/6 incorpora de serie ruedas dotadas de freno. Medidas de 60 x 80 cm. hasta 100 x 120 cm.

SUPPORTS

ENG. Support for cork boards and slates made with metal tube. Adjustable in height. Ref. 770/6 incorporates standard wheels with brake. Sizes between 60 x 80 cm. until 100 x 120 cm.

PIÈTEMENTS

FRA. Support pour tableaux fabriqués avec tubes métalliques. Réglable en hauteur. La réf. 770/6 incorpore de série des roues dotées de frein. Mesures entre 60 x 80cm. en haut 100 x 120 cm.

720/D - 720/T

PIZARRA DÍPTICA/TRÍPTICA
DOUBLE/TRIPLE WHITEBOARD -
TABLEAU DYPTIQUE/TRYPHIQUE



| REF | | | | |
|---------------|-----------|----------|-----|----|
| 720/D1 | 90 x 120 | 90 x 60 | 2+2 | 30 |
| 720/D2 | 120 x 180 | 120 x 90 | 2+2 | 30 |



| REF | | | | |
|---------------|-----------|-----------|-----|----|
| 720/T1 | 90 x 240 | 90 x 120 | 2+4 | 30 |
| 720/T2 | 120 x 400 | 120 x 200 | 2+4 | 30 |

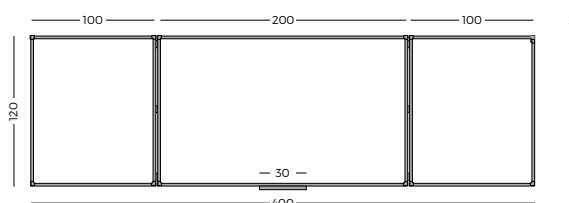
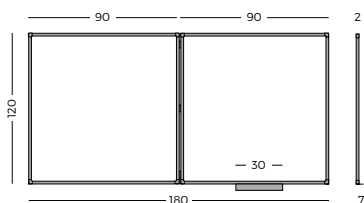

PIZARRA DÍPTICA/TRÍPTICA

ESP. Pizarra blanca díptica o tríptica de acero vitrificado blanco. Enmarcada con perfil de aluminio anodizado en color plata mate y cantoneras redondeadas de plástico gris. Superficie de acero vitrificado a 800°C. Rotulable en seco. Magnética. Cajetín de 30 cm. incluido. 3 o 5 superficies de escritura.

DOUBLE/TRIPLE WHITEBOARD

ENG. Double or triple enamelled whiteboard. Equipped with silver anodized aluminium frame and grey plastic rounded corners. Surface enamelled at 800°C. Suitable for writing with dry wipe board markers. Magnetic. 30 cm. pen tray included. 3 or 5 writing surfaces

TABLEAU DYPTIQUE/TRYPHIQUE

FRA. Tableau diptyque ou triptyc blanc en acier émaillé. Cadre en aluminium anodisé couleur argent aux coins arrondis en plastique gris. Surface émaillée vitrifiée à 800°C. Effaçable à sec. Magnétique. Livré avec un auget de 30 cm. 3 ou 5 surfaces d'écriture.



720/X - 725/X

PIZARRA BLANCA VOLTEABLE
REVOLVING WHITEBOARD - TABLEAU BLANC PIVOTANT



| REF | ↑ | L | HT | □ |
|---------------|-----|-----------|----|-----|
| 720/X1 | 210 | 120 x 150 | 53 | 100 |
| 720/X2 | 210 | 120 x 175 | 53 | 100 |
| 720/X3 | 210 | 120 x 200 | 53 | 100 |



| REF | ↑ | L | HT | □ |
|---------------|-----|-----------|----|-----|
| 725/X1 | 210 | 120 x 150 | 53 | 100 |
| 725/X2 | 210 | 120 x 175 | 53 | 100 |
| 725/X3 | 210 | 120 x 200 | 53 | 100 |

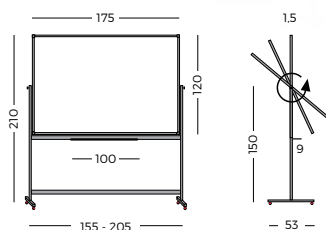

PIZARRA VOLTEABLE

ESP. Pizarra volteable de doble cara laminada o de acero vitrificado. Enmarcada con perfil de aluminio anodizado en color plata mate y cantoneras redondeadas de plástico gris. Rotulable en seco. Estructura volteable metálica móvil provista de 4 ruedas, 2 de ellas con freno.

REVOLVING WHITEBOARD

ENG. Revolving double sided enamelled or laminated whiteboard. Equipped with silver anodized aluminium frame and grey plastic rounded corners. Suitable for writing with dry wipe board markers. Metallic moveable support equipped with 4 castors, 2 of them with brakes.

TABLEAU BLANC PIVOTANT

FRA. Tableau double surface émaillé ou stratifié blanc rotatif. Encadrement en aluminium anodisé argent aux coins arrondis en plastique gris. Monté sur piétement. Effaçable à sec. Support métallique équipé de 4 roulettes, donc 2 à freins.

720/VV

PIZARRA DE VAIVÉN
VAIVÉN BOARD - TABLEAU VA-ET-VIENT

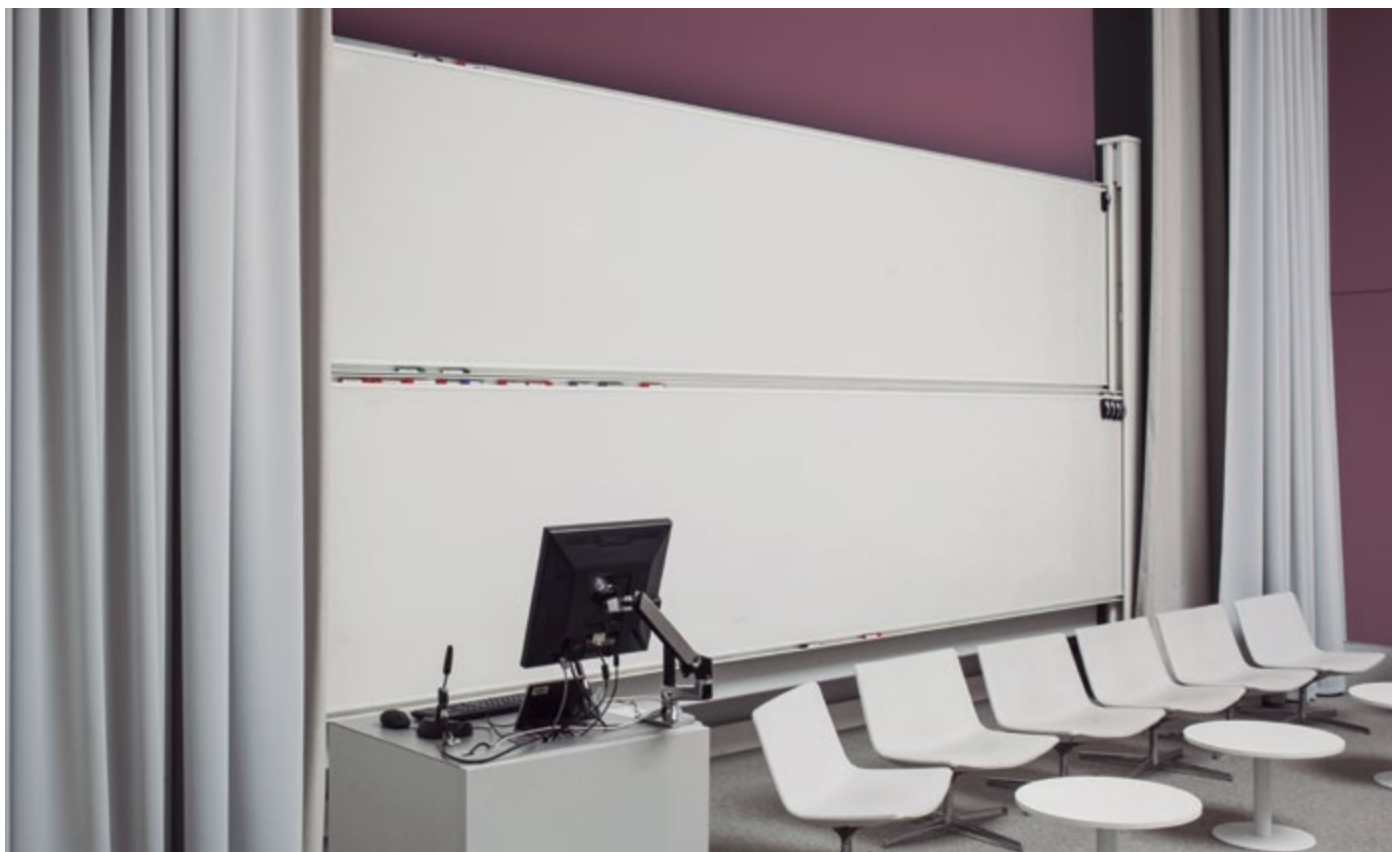

| REF | | L | H |
|-----------|---|-----------|----|
| 720/2/VV1 | x | 120 x 200 | 12 |
| 720/2/VV2 | x | 120 x 250 | 12 |
| 720/2/VV3 | x | 120 x 300 | 12 |
| 720/2/VV4 | x | 120 x 400 | 12 |

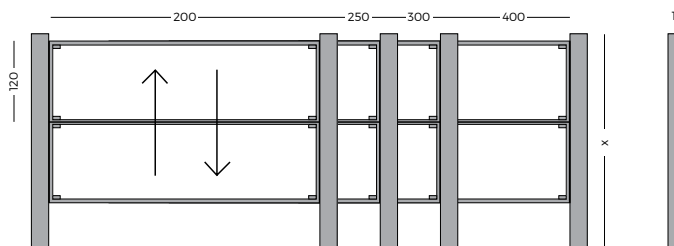

PIZARRA VAIVÉN

ESP. Pizarra de acero vitrificado blanco sobre una estructura de aluminio anodizado en plata mate montada sobre suelo y pared. La pizarra se desliza y va guiada en el perfil por rodamientos de nylon. Ideales para colegios, universidades, anfiteatros...

WHITEBOARD VAIVEN

ENG. Enamelled whiteboard mounted upon a supporting structure in silver anodized aluminium on stand or wall fixation. The surface slide is guided through a cable transmission. The ideal communication tool for large scale presentations, lecture theatres...

TABLEAU VA-ET-VIENT

FRA. Tableau blanc émaillé monté sur une structure en aluminium anodisé couleur argent, fixation sol et mur. La surface se déplace sur le profil via des roulements. Pour une communication idéale dans les amphithéâtres, salles de congrès...



720/G

PIZARRA DE GUILLOTINA
GUILLOTINE BOARD - TABLEAU GUILLOTINE

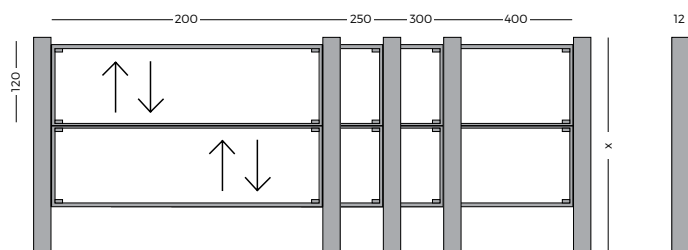

| REF | | L | H |
|----------|---|-----------|----|
| 720/2/G1 | x | 120 x 200 | 12 |
| 720/2/G2 | x | 120 x 250 | 12 |
| 720/2/G3 | x | 120 x 300 | 12 |
| 720/2/G4 | x | 120 x 400 | 12 |



PIZARRA GUILLOTINA

ESP. Conjunto de 2 pizarras blancas de acero vitrificado sobre una estructura de aluminio anodizado en plata mate montadas sobre suelo y pared. Las pizarras son independientes entre sí, guiadas por rodamiento de nylon.

GUILLOTINE BOARD

ENG. 2 enamelled whiteboards mounted upon a supporting structure in silver anodized aluminium on stand or wall fixation. Both writing surfaces slide vertically and are interdependent or each other. Guidance by nylon castors.

TABLEAU GUILLOTINE

FRA. Ensemble de 2 tableaux blancs émaillés montés sur une structure en aluminium anodisé couleur argent, fixation sol et mur. Les deux surfaces se déplacent de façon indépendantes et sont guidées par des roulements.

CHAMELEON SHARP

PIZARRA DE ACERO VITRIFICADO
ENAMELLED WHITEBOARD - TABLEAU ÉMAILLÉ



| REF | L | H |
|---------|-----------|---|
| 7201/10 | 58 x 88 | 1 |
| 7201/1 | 88 x 118 | 1 |
| 7201/2 | 88 x 178 | 1 |
| 7201/3 | 98 x 98 | 1 |
| 7201/4 | 98 x 148 | 1 |
| 7201/5 | 98 x 198 | 1 |
| 7201/6 | 118 x 148 | 1 |
| 7201/7 | 118 x 178 | 1 |
| 7201/8 | 118 x 238 | 1 |
| 7201/9 | 118 x 298 | 1 |

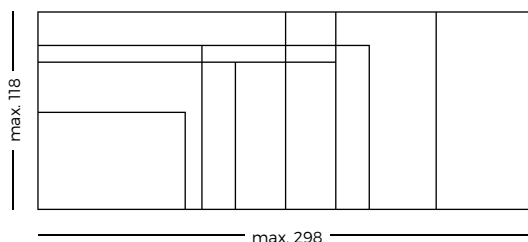

PIZARRA CHAMELEON SHARP

ESP. Pizarra sin marco de 10 mm con borde lacado en blanco. Fabricado con acero vitrificado de doble capa de esmalte fundido a 800°C. El resultado es una superficie de escritura magnética, de borrado en seco. Sin poros, que evita la acumulación de tinta. Resistente a rayaduras y oxidación.

CHAMELEON SHARP WHITEBOARD

ENG. Frameless rectangular whiteboard 10 mm panel with right-angled corners and white lacquered edges. Made of high-grade white enamelled steel (fired at 800°C). Magnetic and dry erasable. The surface is pore-free and mirror smooth. Ink has no chance to accumulate.

TABLEAU CHAMELEON SHARP

FRA. Tableau rectangulaire sans cadre de 10mm d'épaisseur avec bord à angles droits laqués blanc. Surface en acier magnétique vitrifiée à 800°C. Effaçable à sec. Personnalisation disponible: toute forme et impression en couleur.



CHAMELEON CURVE

PIZARRA DE ACERO VITRIFICADO
ENAMELLED WHITEBOARD - TABLEAU ÉMAILLÉ

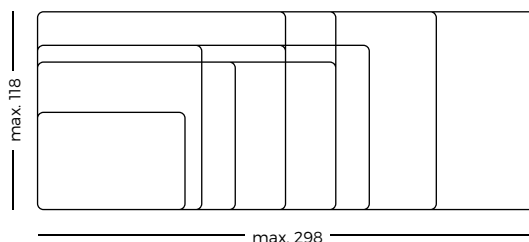
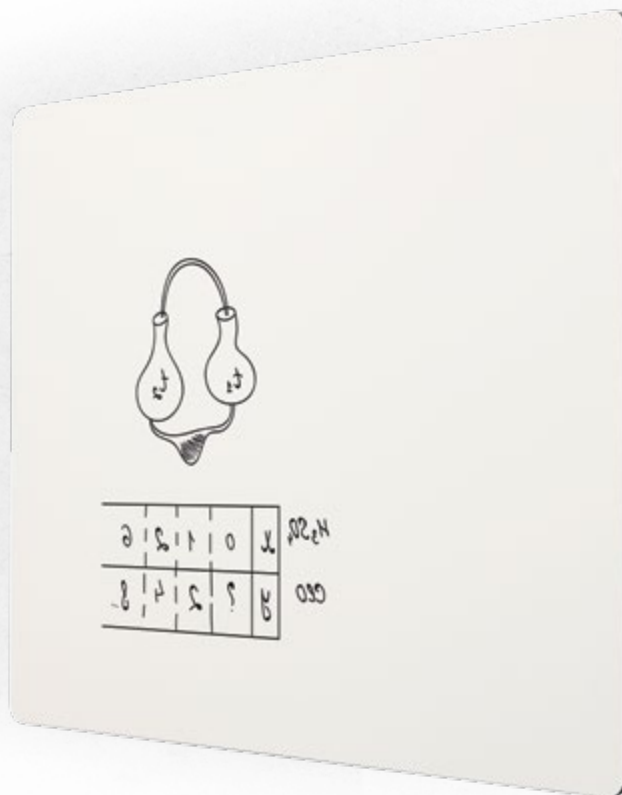

| REF | L | H |
|----------------|-----------|---|
| 7202/10 | 58 x 88 | 1 |
| 7202/1 | 88 x 118 | 1 |
| 7202/2 | 88 x 178 | 1 |
| 7202/3 | 98 x 98 | 1 |
| 7202/4 | 98 x 148 | 1 |
| 7202/5 | 98 x 198 | 1 |
| 7202/6 | 118 x 148 | 1 |
| 7202/7 | 118 x 178 | 1 |
| 7202/8 | 118 x 238 | 1 |
| 7202/9 | 118 x 298 | 1 |



PIZARRA CHAMELEON CURVE

ESP. Pizarra rectangular sin marco de 10mm con borde redondeado lacado en negro. Superficie magnética de acero vitrificado a 800°C. Rotulable en seco. Personalización disponible: cualquier forma y impresión a todo color.

CHAMELEON CURVE WHITEBOARD

ENG. Frameless rectangular whiteboard 10 mm panel with rounded corners and black lacquered edges. Made of high-grade white enamelled steel (fired at 800°C). Magnetic and dry erasable. Customization available: any shape and full-colour printed surface.

TABLEAU CHAMELEON CURVE

FRA. Tableau rectangulaire sans cadre de 10mm d'épaisseur avec bord arrondi laqué noir. Surface en acier magnétique vitrifiée à 800°C. Effaçable à sec. Personnalisation disponible : toute forme et impression en couleur.

CHAMELEON WALL

PIZARRA DE ACERO VITRIFICADO
 ENAMELLED WHITEBOARD - TABLEAU ÉMAILLÉ



| REF | L | H | PANELS |
|-----------|-----------|---|--------|
| 7201/I/W3 | 118 x 264 | 1 | 3 |
| 7201/I/W4 | 118 x 352 | 1 | 4 |
| 7201/I/W5 | 118 x 440 | 1 | 5 |
| 7201/S/W3 | 198 x 294 | 1 | 3 |
| 7201/S/W4 | 198 x 392 | 1 | 4 |
| 7201/S/W5 | 198 x 490 | 1 | 5 |

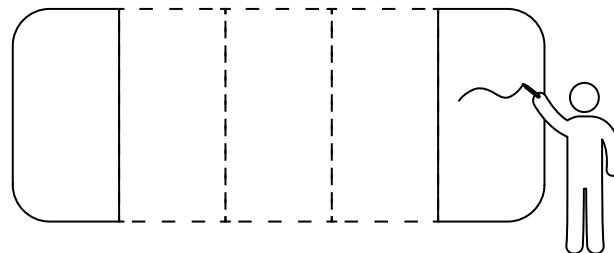

PIZARRA CHAMELEON WALL

ESP. Pizarras de gran formato con diseño modular que encaja en cualquier posición. Crea una superficie prácticamente sin fisuras que puede adaptarse a las medidas de cualquier sala gracias a la unión de diferentes paneles con unión prácticamente invisible.

WALL CHAMELEON WHITEBOARD

ENG. Broad whiteboards, very easy to link side by side or above each other. This creates an almost seamless whiteboard wall which can be tailored to the dimensions of your room thanks to its precise cut.

TABLEAU WALL CHAMELEON

FRA. Tableau grand format avec une conception modulaire s'adaptant à n'importe quelle position. Superficie sans profil ni encadrement qui peut être adaptée aux mesures de n'importe quelle pièce grâce à l'union de différents panneaux avec une séparation presque invisible.

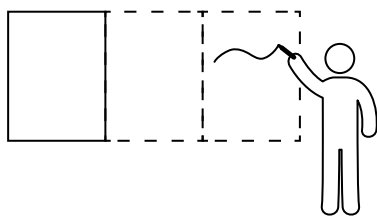
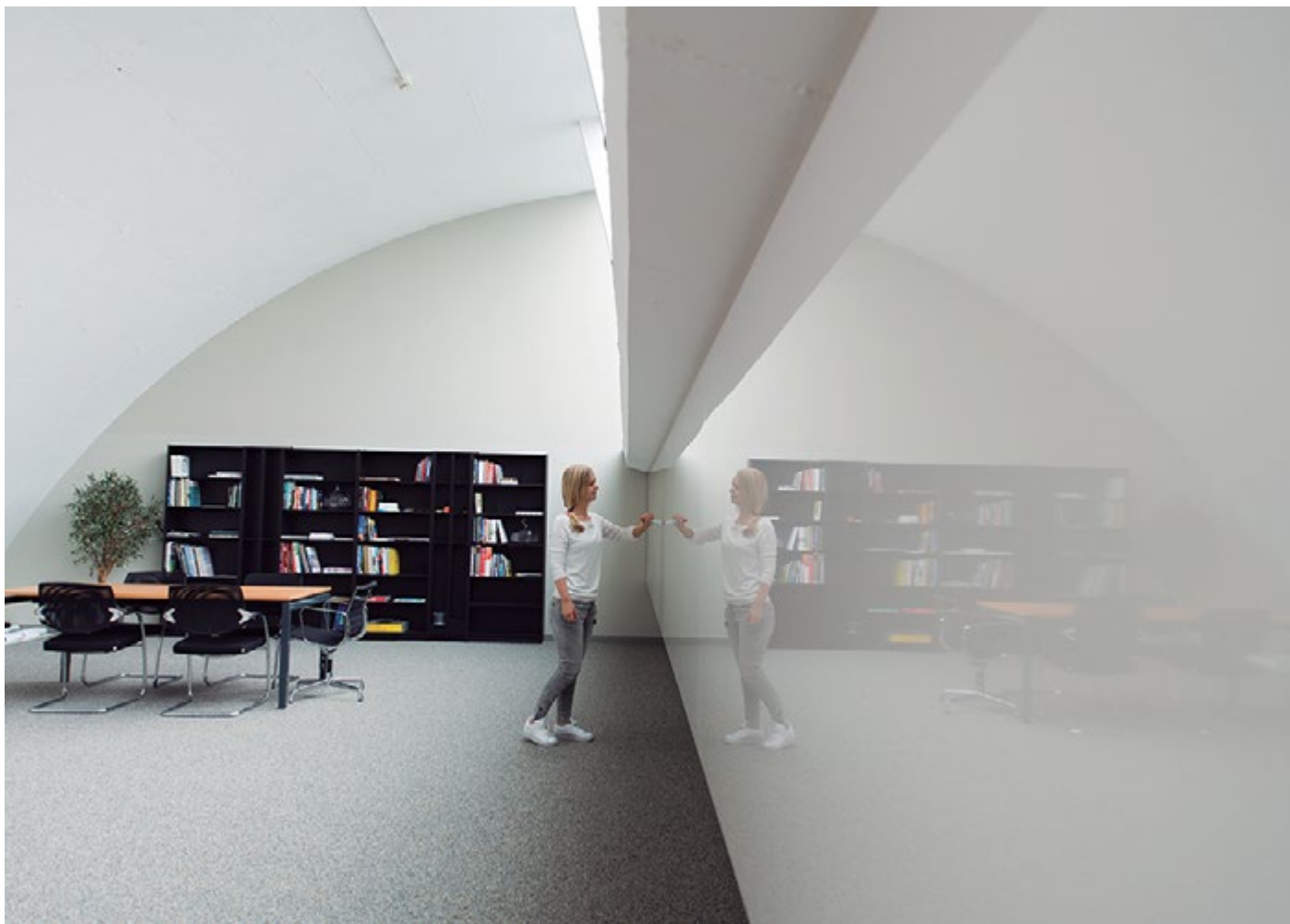

REF L H **PANELS**
7201/1/W... 118 x 88 1 1

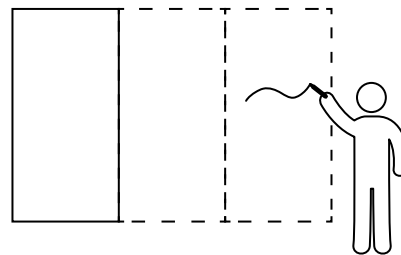

REF L H **PANELS**
7201/5/W... 198 x 98 1 1



CHAMELEON SIX-SQUARE/ROUND

PIZARRA DE ACERO VITRIFICADO
ENAMELLED WHITEBOARD - TABLEAU ÉMAILLÉ

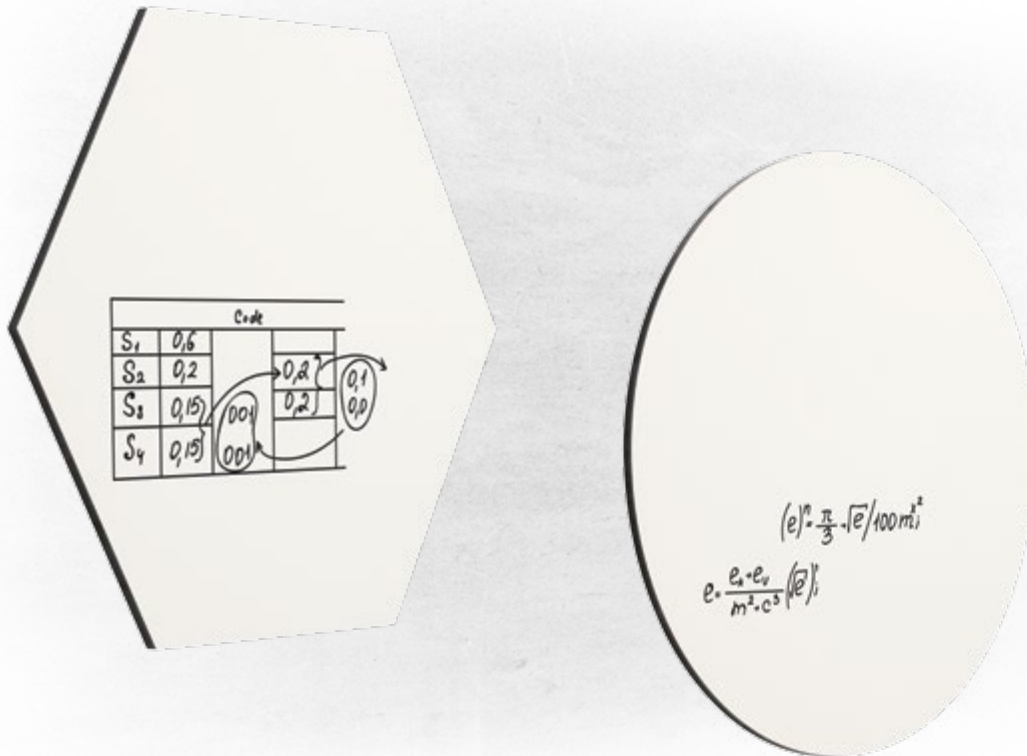

| REF | L | -H- |
|--------|------|-----|
| 7206/1 | φ60 | 1 |
| 7206/2 | φ98 | 1 |
| 7206/3 | φ118 | 1 |



| REF | L | -H- |
|--------|------|-----|
| 7208/1 | φ60 | 1 |
| 7208/2 | φ98 | 1 |
| 7208/3 | φ118 | 1 |

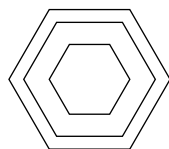

max. φ118

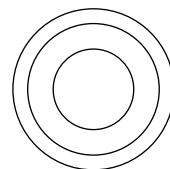

max. φ118

PIZARRA CHAMELEON

ESP. Pizarra hexagonal o circular sin marco de 10mm con borde redondeado lacado en negro. Superficie magnética de acero vitrificado a 800°C. Rotulable en seco. Personalización disponible: cualquier forma y impresión a todo color.

CHAMELEON WHITEBOARD

ENG. Frameless rectangular or round whiteboard 10 mm panel with rounded corners and black lacquered edges. Made of high-grade white enamelled steel (fired at 800°C). Magnetic and dry erasable. Customization available: any shape and full-colour printed surface.

TABLEAU CHAMELEON

FRA. Tableau hexagonal ou rond sans cadre de 10mm d'épaisseur avec bord arrondi laqué noir. Surface en acier magnétique vitrifiée à 800°C. Effaçable à sec. Personnalisation disponible: toutes formes et impression en couleur.

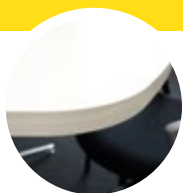

CHAMELEON TABLE-TOP

TABLERO DE ACERO VITRIFICADO
ENAMELLED TABLE-TOP - TABLEAU ÉMAILLÉ



| REF | L | H |
|--------|-----------|-----|
| 7210/1 | 180 x 90 | 2.5 |
| 7210/2 | 220 x 100 | 2.5 |
| 7210/3 | 298 x 118 | 2.5 |

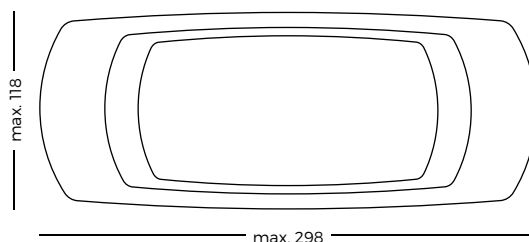

TABLERO DE ACERO VITRIFICADO

ESP. Tablero de 2.5 cm de grosor para utilizar como mesa rotulable. Superficie magnética de acero vitrificado a 800°C, para un uso intensivo y constante. Rotulable en seco. Personalización disponible: cualquier forma y impresión a todo color. Patas no incluidas.

ENAMELLED TABLE-TOP

ENG. Frameless rectangular board to use as table-top. Made of high-grade white enamelled steel (fired at 800°C). Magnetic and dry erasable. Customization available: any shape and full-colour printed surface. Legs not included.

TABLE EN ACIER ÉMAILLÉ

FRA. Panneau de 2.5 cm d'épaisseur pour une utilisation comme table effaçable à sec. Surface en acier émaillé, magnétique, vitrifiée à 800°C, pour une utilisation intensive et constante. Personnalisation disponible: toutes formes et impression en couleur. Pieds non inclus.

CHAMELEON CUSTOM

PIZARRA DE ACERO VITRIFICADO
ENAMELLED WHITEBOARD - TABLEAU ÉMAILLÉ



| REF | L | H | ACABADO |
|-----------|----------------|---|---------|
| 7200/M2/B | max. 118 x 298 | 1 | Brillo |
| 7200/M2/M | max. 118 x 298 | 1 | Mate |
| 7200/LOGO | Logo | - | - |
| 7200/SKY | Skyline | - | - |

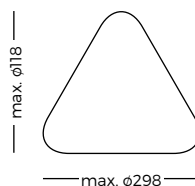

PIZARRA CHAMELEON PERSONALIZADA

ESP. Pizarra de cualquier forma sin marco de 10mm. Superficie magnética de acero vitrificado a 800°C. Rotulable en seco. Diseño de una pieza ajustable a medida máxima de 118x298 cm.

CHAMELEON CUSTOM WHITEBOARD

ENG. Frameless whiteboard 10 mm panel in any shape. Made of high-grade white enamelled steel (fired at 800°C). Magnetic and dry erasable. Each design must fit in a 118x298 rectangle.

TABLEAU CHAMELEON PERSONNALISÉ

FRA. Tableau de toutes formes sans cadre de 10mm d'épaisseur avec bord arrondi laqué noir. Surface en acier magnétique vitrifiée à 800°C. Effaçable à sec. Conception d'une pièce ajustable aux dimensions maximum de 118x298 cm.



CHAMELEON CUSTOM

PIZARRA DE ACERO VITRIFICADO
ENAMELLED WHITEBOARD - TABLEAU ÉMAILLÉ



| REF | L | ACABADO |
|-----------|----------------|----------|
| 7200/M2/B | max. 118 x 298 | 1 Brillo |
| 7200/M2/M | max. 118 x 298 | 1 Mate |
| 7200/LOGO | Logo | - |
| 7200/SKY | Skyline | - |

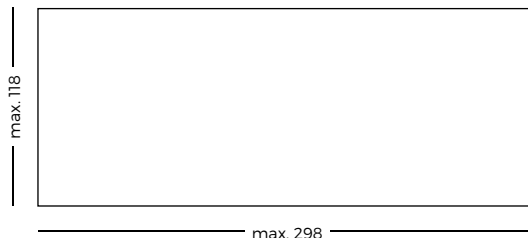

PIZARRA CHAMELEON PERSONALIZADA

ESP. Crea una pizarra única. Posibilidad de cortar un logotipo en el interior o una silueta en la parte superior. Impresión a todo color en toda la superficie también disponible. Posibilidad de crear pizarras con calendarios, dibujos o logotipos.

CHAMELEON CUSTOM WHITEBOARD

ENG. Multiple options to create your own unique whiteboard that no one else has. Have your own logo cut into the whiteboard or design a cutout at the top. Full colour printing is also an option on the whiteboard.

TABLEAU CHAMELEON PERSONNALISÉ

FRA. Possibilité de créer votre propre tableau. Découper un logo à l'intérieur ou une silhouette sur le dessus. Impression en couleur sur toute la surface également disponible. Possibilité de créer des tableaux avec calendriers, designs et logos.

CHAMELEON PROYECCIÓN

PIZARRA DE ACERO VITRIFICADO BLANCO MATE
ENAMELLED MATT WHITEBOARD - TABLEAU ÉMAILLÉ MAT

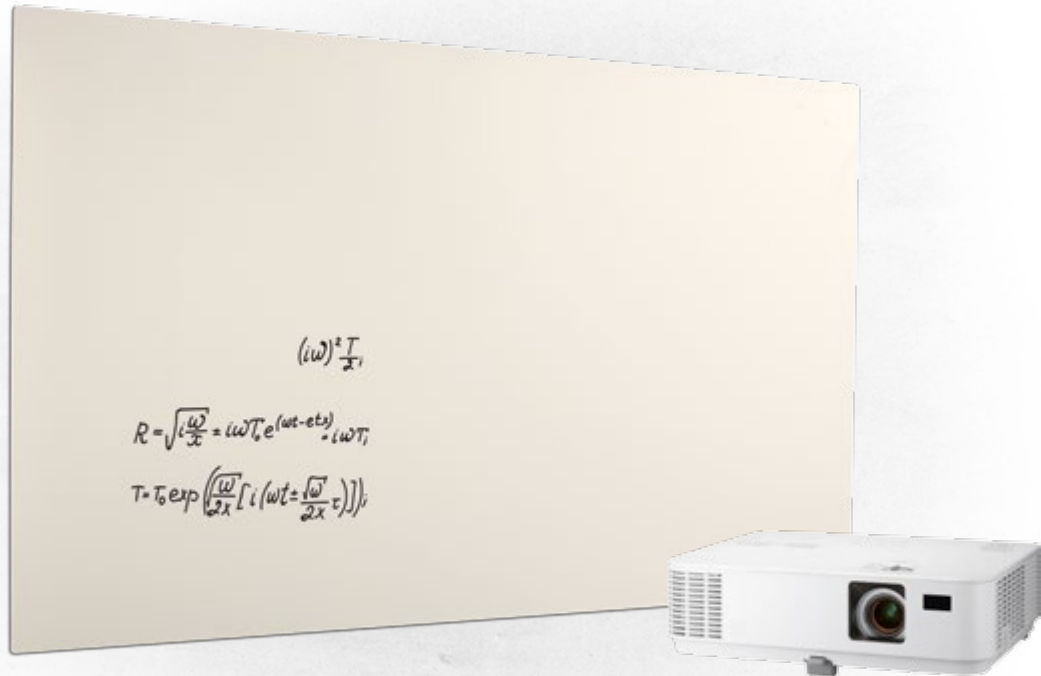

| REF | L | H | m ² | ACABADO |
|-----------|----------------|---|----------------|---------|
| 7200/M2/M | max. 118 x 298 | 1 | 1 | Mate |

| REF | L | H |
|----------|-----------|---|
| 7201/6/M | 118 x 148 | 1 |
| 7201/7/M | 118 x 178 | 1 |
| 7201/8/M | 118 x 238 | 1 |
| 7201/9/M | 118 x 298 | 1 |

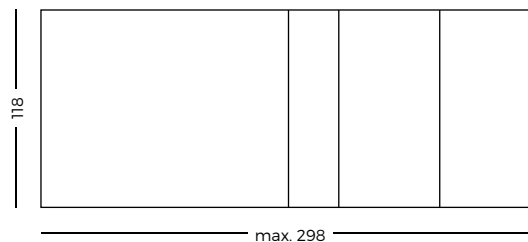

Projector no incluido
Projector not included
Projecteur non inclus



PIZARRA CHAMELEON MATE

ESP. Pizarra mate sin marco de 10 mm con borde lacado en blanco. Fabricado con acero vitrificado de doble capa de esmalte fundido a 800°C. El resultado es una superficie de escritura magnética, de borrado en seco. Resistente a rayaduras y oxidación. Permite la proyección.

CHAMELEON MATT WHITEBOARD

ENG. Matt frameless rectangular whiteboard 10 mm panel with right-angled corners and white lacquered edges. Made of high-grade white enamelled steel (fired at 800°C). Magnetic and dry erasable. Suited for projection.

TABLEAU CHAMELEON MAT

FRA. Tableau blanc mate sans cadre de 10 mm d'épaisseur avec bord laqué blanc. Fabriqué en acier émaillé double émail cuite à 800°C. Le résultat est une surface d'écriture magnétique, effaçable à sec. Résistant aux rayures et à l'oxydation. La couleur blanc mate permet une projection de vos images et vidéos sans reflets.

CHAMELEON MOBILE

PIZARRA MÓVIL DE ACERO VITRIFICADO
 ENAMELLED MOBILE WHITEBOARD - TABLEAU MOBILE ÉMAILLÉ



REF L H
 7215/1 192,3 x 88,6 53,9

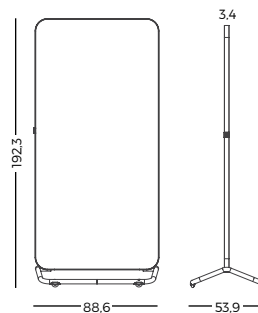

COLORES



Consultar para colores especiales.

PIZARRA CHAMELEON MÓVIL

ESP. Pizarra móvil, con superficie de acero vitrificado de doble capa de esmalte fundido a 800°C. Superficie de escritura sin poros, magnética, de borrado en seco. Estructura metálica con ruedas. Incluye tirador de cuero en el lateral de la pizarra para su transporte alrededor de la sala.

CHAMELEON MOBILE WHITEBOARD

ENG. Mobile whiteboard, made from high-grade white enamelled steel (fired at 800°C). Magnetic and dry erasable. The surface is pore-free and mirror smooth. Metallic structure with casters. Includes handle for easy transportation.

TABLEAU CHAMELEON MOBILE

FRA. Tableau mobile, surface en acier vitrifiée à 800°C. Effaçable à sec et magnétique. Surface sans pores et lisse. Structure métallique avec roulettes. Comprend une poignée pour un transport facile.



CHAMELEON MOMENTUM

PIZARRA DE ACERO VITRIFICADO
ENAMELLED WHITEBOARD - TABLEAU ÉMAILLÉ



COLORES



/BL /AZ /GR

Consultar para colores especiales.

REF

7216/1



190,4 x 75,7



70 x 130



2,5

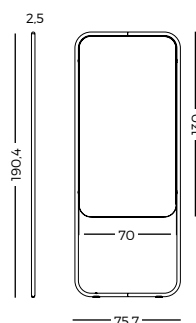

PIZARRA CHAMELEON MOMENTUM

ESP. Pizarra portátil, de peso ligero. Superficie de acero vitrificado de doble capa de esmalte fundido a 800°C. Superficie de escritura sin poros, magnética, de borrado en seco. Estructura metálica.

CHAMELEON MOMENTUM WHITEBOARD

ENG. Light weight portable whiteboard, made from high-grade white enamelled steel (fired at 800°C). Magnetic and dry erasable. The surface is pore-free and mirror smooth. Metallic structure.

TABLEAU CHAMELEON MOMENTUM

FRA. Tableau portable, surface en acier vitrifiée à 800°C. Effaçable à sec et magnétique. Surface sans pores et lisse. Structure métallique.

LEAN

PIZARRA DE ACERO VITRIFICADO LEAN
 LEAN ENAMELLED WHITEBOARD - TABLEAU MOBILE LEAN



| REF | 720 | L | H | □ |
|--------|-------|-----------|-----|----|
| 1500/1 | 720/3 | 100 x 120 | 1,5 | 30 |
| 1500/2 | 720/4 | 100 x 150 | 1,5 | 30 |
| 1500/3 | 720/6 | 120 x 200 | 1,5 | 30 |

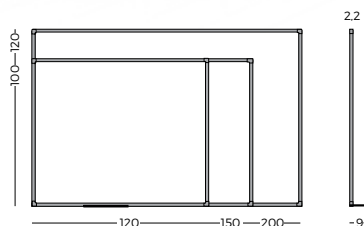

PIZARRA LEAN DE ACERO VITRIFICADO

ESP. Pizarra de acero vitrificado blanco personalizada. Enmarcada con perfil de aluminio anodizado en color plata. Superficie de acero vitrificado a 800°C con garantía de por vida. Superficie magnética personalizable para implementar en fábricas, oficinas u organizar procesos. Consultar con la oficina técnica para su diseño personalizado.

LEAN ENAMELLED WHITEBOARD

ENG. Whiteboard equipped with silver anodized aluminium frame and plastic rounded corners. Surface enamelled at 800°C. Customizable surface for use in factories, offices and for organizational processes. Consult our technical department for your custom design.

TABLEAU ÉMAILLÉ LEAN

FRA. Tableau émaillé blanc avec encadrement en aluminium anodisé couleur argent aux coins arrondis en plastique. Surface magnétique émaillée vitrifiée à 800°C. Superficie personnalisable afin de l'implanter en usine, bureaux... Consultez nous pour un dessin personnalisé.

EJEMPLOS
EXAMPLES - EXEMPLES

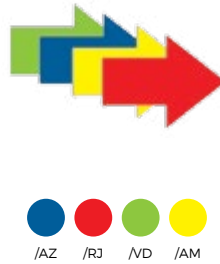

| REF | L | U. | DISEÑO |
|-------|------|-------------------|--------|
| KL/01 | ø3.5 | 15 u. (5 x color) | emoji |
| KL/02 | ø3.5 | 15 u. (5 x color) | tick |
| KL/03 | ø3.5 | 15 u. (5 x color) | ? |
| KL/04 | ø3.5 | 15 u. (5 x color) | ! |

| | | | |
|-------|----|---|--------------------|
| KL/11 | ø5 | 5 | emoji - doble cara |
| KL/12 | ø5 | 5 | tick - doble cara |
| KL/13 | ø5 | 5 | ? - doble cara |
| KL/14 | ø5 | 5 | ! - doble cara |

| | | | |
|-------|-------|---|---------|
| KL/21 | 2 x 3 | 5 | arrow → |
|-------|-------|---|---------|

| REF | L | DIN | U. | DISEÑO |
|-------|-----------|-----|----|------------|
| KL/A4 | 210 x 297 | A4 | 5 | Funda mag. |
| KL/A3 | 297 x 420 | A3 | 5 | Funda mag. |



ACCESORIOS

ESP. Accesorios de diferentes colores y diseños para el uso con una pizarra LEAN. Ideal para marcar procesos completados u organizar tareas industriales. Productos disponibles: Pack de 15 imanes de 3 colores, de 5 imanes de doble cara, de 5 flechas en 4 colores o fundas DIN A4 o DIN A3 de colores.

ACCESORIES

ENG. Accessories in a selection of different colors and designs for use with a LEAN slate. Ideal for marking completed processes or organizing industrial tasks. Available products: pack of 15 3-color magnets, 5 double-sided magnets, 5 arrows in 4 colors or DIN A4 or DIN A3 colored.

ACCESOIRES

FRA. Accessoires de différentes couleurs et conceptions pour un usage sur tableau LEAN. Idéal pour lister ou marquer vos tâches et autres procédures. Produits disponibles: pack de 15 aimants de 3 couleurs, de 5 aimants doubles faces, de 5 flèches en 4 couleurs ou pochettes DIN A4 ou A3 de couleurs.

FLIPCHARTS

PIZARRA DE CABALLETE
FLIPCHART WHITEBOARD - CHEVALET TABLEAU



REF 704/N 190 100 x 80 90

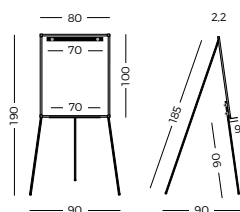

REF 711/N 180 100 x 70 70

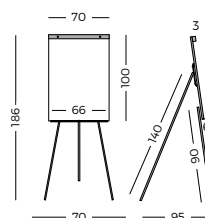

PIZARRA CABALLETE

ESP. Pizarras de caballete lacadas de color blanco. Rotulable en seco. Soporte tipo trípode de diferentes diseños, ajustable en altura según apertura de la pata trasera. Soporte para blocs de papel incluido.

FLIPCHART

ENG. Lacquered easel whiteboards with tripod type stand in different designs. Suitable for writing with dry wipe board markers. Magnetic. Support for paper flipcharts included. Height-adjustable.

CHEVALET

FRA. Chevalet tableaux laqués blanc de différents designs et conceptions. Effaçable à sec. Magnétique. Support bloc papier inclus. Hauteur réglable.



REF ↑ ↙ ⇄
709/E 195 100 x 70 70



REF ↑ ↙ ⇄
709/N 181 100 x 68 95

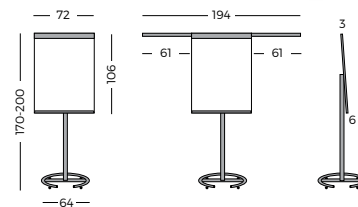
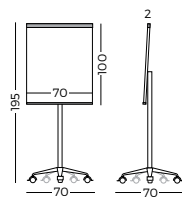

PIZARRA DE PIÉ CON RUEDAS

ESP. Pizarras de pie con ruedas de diferentes cualidades y diseños. Superficie blanca magnética y brazos extensibles en ambos lados en la referencia 709/N. Soporte para blocs de papel incluido. Altura graduable.

FLIPCHART ON CASTERS

ENG. Mobile white boards on casters in varied qualities and designs. Magnetic white surface and extendable arms on both sides in 709/N. Support for paper pads included. Adjustable height.

CHEVALET AVEC ROULETTES

FRA. Chevalet tableau avec roue de différentes qualités et conceptions. Superficie blanche magnétique avec bras extensibles des deux côtés pour la version 709/N. Support bloc papier inclus. Hauteur réglable.

1000

PLANNING MAGNÉTICO
MAGNETIC PLANNER - PLANNING MAGNÉTIQUE

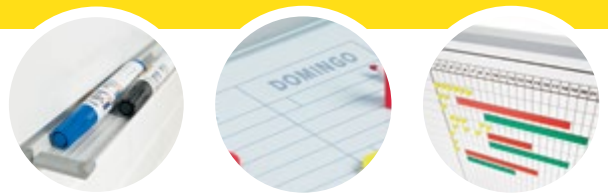

REF L H

1000/50 90 x 120 1.5

1000/60 90 x 120 1.5

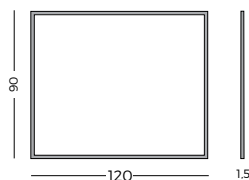

PLANNING MAGNÉTICO

ESP. Pizarra para planning lacada blanca y con serigrafía. Rotulable con rotuladores de borrado en seco. Magnética. enmarcado con perfil de aluminio anodizado en color plata mate y cantoneras redondeadas grises. Incluye un cajetín reposarrotuladores de 30 cm.

MAGNETIC PLANNER

ENG. Lacquered whiteboard with screen printed planner. Suitable for writing with dry wipe board markers. Magnetic. Equipped with silver anodized aluminium frame and grey plastic rounded corners. A 30 cm. pen tray included.

PLANNING MAGNÉTIQUE

FRA. Tableau laqué blanc avec impression planning serigraphié. Encadrement en aluminium anodisé couleur argent aux coins arrondis en plastique gris. Effaçable à sec. Magnétique. Livré avec auget porte marqueurs 30 cm.



VIDEOPROYECTORES

VIDEPROYECTORES
PROJECTORS - VIDÉOPROJECTEURS



| REF | CALIDAD | FUNCION. | ANSI LÚMEN | CONT. |
|--------------|-------------|-------------|------------|---------|
| VPD/1 | Básico | Sobremesa | 3000 | 10000:1 |
| VPD/2 | Profesional | Sobremesa | 3300 | 6000:1 |
| VPD/3 | Profesional | Instalación | 6000 | 20000:1 |
| VPD/4 | Profesional | Instalación | 3300 | 10000:1 |
| VPD/5 | Standard | Sobremesa | 3000 | 4000:1 |



VIDEOPROYECTORES

ESP. Videoproyectores compactos y portátiles de altas prestaciones indicado para instalaciones o presentaciones móviles. Estos proyectores tienen un uso polivalente tanto para la educación como en empresas por su portabilidad. Ofrecen gran luminosidad.

VIDEOPROJECTOR

ENG. Portable compact video projectors with high performance suitable for installations or mobile presentations. These projectors have a multipurpose use for education and for the company due to its portability, and offers high luminosity.

VIDÉOPROJECTEURS

FRA. Gamme complète de vidéoprojecteurs polyvalent pour l'éducation et les entreprises. Performants, léger et très lumineux, vous y trouverez un produit adapté, une entrée, un moyen et un haut de gamme.



SOPORTES 410

SOPORTES AJUSTABLES
ADJUSTABLE BRACKETS - SUPPORT PLAFOND INCLINABLE



| REF | ↑ | ↓ |
|------------|------|----|
| 410/06/100 | 8/98 | 22 |
| 410/06 | 17 | 22 |

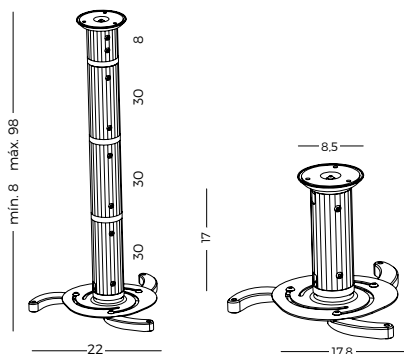

| REF | ↑ | ↓ |
|--------|------|--------|
| 410/20 | 20.3 | 73/123 |

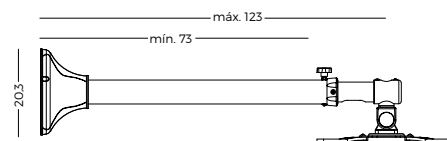

SOPORTES AJUSTABLES

ESP. Soporte metálico de fijación a techo o pared para videoproyectores con un máximo de 12 kg. Acabado en color gris metalizado.

ADJUSTABLE BRACKETS

ENG. Ceiling brackets for videoprojector up to 12 Kg. Suitable for most of the projectors thanks to 3 or 4 arms mounting pattern. Easy to install thanks to a hook-in system.

SUPPORTS RÉGLABLES

FRA. Support métallique se fixant au plafond ou au sol pour vidéoprojecteurs jusqu'à 12 Kg. Finition gris métallisé.



PANTALLAS

PANTALLA CON TRÍPODE
SCREEN WITH TRIPOD - ÉCRAN DE PROJECTION



| | | | |
|--------------|-----------|-----|------|
| REF | L | I | H |
| PT/T2 | 180 x 180 | 270 | 13,5 |

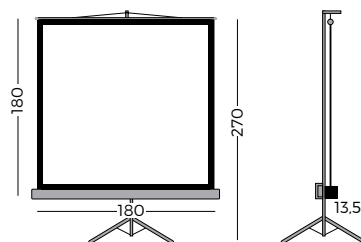

PANTALLA CON TRÍPODE

ESP. Pantalla de proyección con trípode. La carcasa de gran diseño, está fabricada en chapa plastificada color blanco y la tela es especial antirreflectante. Posee brazo inclinable para corregir la distorsión de la imagen. Estructura plegable. Ganancia: 1,3. Tela M1.

TRIPOD PROJECTOR SCREEN

ENG. Tripod projector screen. The design casing is made entirely of white laminated sheet metal and the fabric is antiglare. Easy to install and to use. The screen has an adjustable inclined bracket to correct image distortion. Foldable structure. Gain 1.3. Fabric M1.

ÉCRAN DE PROJECTION SUR PIED

FRA. Écran de projection sur trépied avec potence télescopique et correction de parallaxe. Carter en tôle plastifiée blanc non réfléchissant. Grande qualité d'image, la toile blanc mat de gain 1,3 est ignifugé M1. Déroulement simple et rapide à la mesure souhaitée.

PANTALLAS

PANTALLA MURAL
WALL PROJECTOR SCREEN - ÉCRAN DE PROJECTION



PANTALLA

| REF | — | — |
|-------|-----------|----|
| PM/T2 | 177 x 177 | 14 |
| PM/T3 | 200 x 200 | 14 |
| PM/T4 | 240 x 240 | 14 |

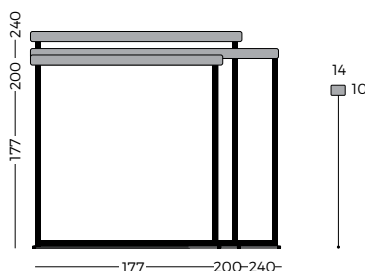

SEPARADOR

| REF | — |
|------|------------|
| SP/1 | 1 - 15 cm. |
| SP/2 | 1 - 35 cm. |



PANTALLA DE PROYECCIÓN

ESP. Pantalla mural de proyección, adaptable a techo y pared. La carcasa está fabricada en chapa plastificada color blanco y la tela es especial antirreflectante. La tela se puede desenrollar a la medida deseada y el enrollado es automático. Ganancia: 1,3. Tela M1.

PROJECTOR SCREEN

ENG. Projector screen for the ceiling and wall. The design casing is made entirely of white laminated sheet metal and the fabric is anti-glare. The fabric can be unrolled to the wished measurement and the rolling up is automatic. Gain 1,3. Fabric M1.

ÉCRAN DE PROJECTION

FRA. Écran de projection manuel, fixation murale et/ou plafond. Carter en tôle plastifiée blanc non réfléchissant. Grande qualité d'image, la toile blanc mat de gain 1,3 est ignifugé M1. Déroulement simple et rapide à la dimension souhaitée.



PANTALLAS ELÉCTRICAS

PANTALLA MURAL ELÉCTRICA
ELECTRICAL PROJECTION SCREEN - ÉCRAN DE PROJECTION ÉLECTRIQUE



Mando a distancia incluido
Remote control included
Télécommande incluse

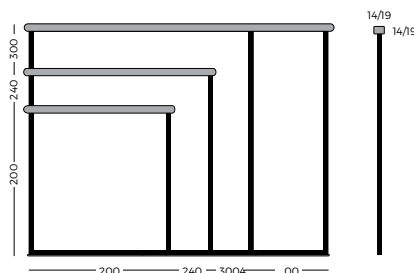

| REF | □ | ⊥ |
|--------|-----------|----|
| PMM/12 | 200 x 200 | 14 |
| PMM/13 | 240 x 240 | 19 |
| PMM/14 | 300 x 300 | 19 |
| PMM/15 | 300 x 400 | 19 |



PANTALLA MURAL ELÉCTRICA

ESP. Pantalla mural de elevación automática por medio de un motor eléctrico adaptable a techo y pared. La carcasa está fabricada en aluminio y la tela es especial antirreflectante. El funcionamiento de la pantalla se acciona mediante un interruptor manual.

ELECTRICAL PROJECTION SCREEN

ENG. Wall or ceiling projection screen. Roll-up mechanism driven through an electrical motor. The design casing is made entirely of aluminium and the fabric is anti-glare. A manual switch (included) or remote controls (optional). Gain 1.3. Fabric M1.

ÉCRAN DE PROJECTION ÉLECTRIQUE

FRA. Écran de projection motorisée. Fixation murale ou plafond. Moteur à vitesse de rotation élevée, permettant une mise en place de l'écran très rapide. Carter en aluminium anodisé de couleur gris, anti-reflets Interrupteur manuel (inclus). Gain 1.3 est ignifugé M1.

ACCESORIOS

ACCESORIOS
ACCESORIES - ACCESSOIRES



7015

ESP. Borrador magnético "Design"
ENG. Magnetic eraser "Design"
FRA. Effaceur magnetique "Design"

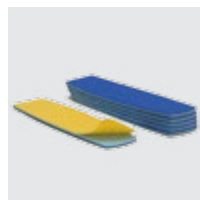

7015/1

5 u.

ESP. Recambio para borrador 7015
ENG. 7015 eraser felt refills
FRA. Feutrines pour effaceur 7015



7014

ESP. Borrador de plástico
ENG. Plastic eraser
FRA. Effaceur en plastique



7014/1

2 u.

ESP. Recambio para borrador 7014
ENG. 7014 eraser felt refills
FRA. Feutrines pour effaceur 7014



7006

ESP. Borrador de aluminio magnético
ENG. Magnetic eraser
FRA. Effaceur magnetique



7012

ESP. Borrador de aluminio
ENG. Eraser
FRA. Effaceur



7006/1

20 u.

ESP. Recambio para borrador 7006 y 7012
ENG. 7006 and 7012 eraser felt refills
FRA. Feutrines pour effaceur 7006 et 7012



7005 - 7005/12

4 u. 12 u.

ESP. Rotuladores de pizarra
ENG. Whiteboard markers
FRA. Marqueurs effaçables à sec



7008

ESP. Aerosol para pizarras (200 ml)
ENG. Whiteboard cleaner spray (200 ml)
FRA. Aerosol pour tableau (200 ml)



7019

ESP. Portarrotuladores magnéticos
ENG. Magnetics marker holder
FRA. Porte marqueurs magnétique



KIT/E

CONTIENE:

4 Rotuladores
Líquido limpiador 50ml.
Borrador magnético OVAL
Fielros recambio borrador
Pack 10 imanes ø20mm.



KIT/T

CONTIENE:

4 Rotuladores
Líquido limpiador 200 ml.
Borrador magnético
Fielros recambio borrador
Pack 10 imanes ø20 mm.
Reposa-rotuladores magnético



PS Capture

App by Planning Sisplamo
www.planningsisplamo.com/pscapture



7001 25 u.

ESP. Bloc de papel liso 90 x 60 cm.
ENG. Pad of plain paper 90 x 60 cm.
FRA. Recharge papier uni 90 x 60 cm.



7002/M

ESP. Pinza portablocs magnética 6 x 65 cm.
ENG. Magnetic pad holder 6 x 65 cm.
FRA. Pince papier magnétique 6 x 65 cm.



7002

ESP. Pinza portablocs 7 x 69 cm.
ENG. Pad holder 7 x 69 cm.
FRA. Pince papier 7 x 69 cm.



7003 - 7003/30 - 7003/50

ESP. Cajetín de 100, 30 ó 50 cm.
ENG. 100, 30 or 50 cm. pen tray.
FRA. Porte-marqueurs de 100, 30 ou 50cm.



9002 - 9003 - 9004 6 u.

ESP. Imanes redondos $\phi 2, \phi 2.5, \phi 3.2$ cm.
ENG. Round magnets $\phi 2, \phi 2.5, \phi 3.2$ cm.
FRA. Aimants ronds $\phi 2, \phi 2.5, \phi 3.2$ cm.



9010 20 u.

ESP. Imanes redondos $\phi 0,9$ cm.
ENG. Round magnets $\phi 0,9$ cm.
FRA. Aimants ronds $\phi 0,9$ cm.



9011 20 u.

ESP. Imanes cuadrados $\phi 0,9$ cm.
ENG. Square magnets $\phi 0,9$ cm.
FRA. Aimants carrés $\phi 0,9$ cm.



7011 50 u.

ESP. Tiras adhesivas de 50 x 0,25 cm.
ENG. Adhesive strips 50 x 0,25 cm.
FRA. Bandes adhésives 50 x 0,25 cm.

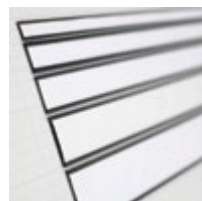

9005 - 9006 - 9007 - 9008 - 9009

ESP. Portarrótulos de 50 cm.
ENG. 50 cm long magnetic title holder.
FRA. Porte-étiquettes 50 cm.

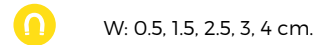

9012 - 9014 W: 0,9, 1,2 cm.

ESP. Tiras magnética de 50 cm.
ENG. Magnetic strips 50 cm.
FRA. Bandes magnetique 50 cm.

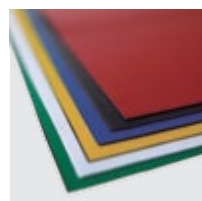

9000

ESP. Placa magnética de 50 x 60 cm.
ENG. Magnetic plaque 50 x 60 cm.
FRA. Plaque magnétique 50 x 60 cm.



ESCOLPLAN

EQUIPAMIENTO ESCOLAR
SCHOOL EQUIPEMENT
EQUIPEMENT SCOLAIRE



SUPERFICIES PS

SUPERFICIES DE ESCRITURA
WRITTING SURFACES - SURFACE D'ÉCRITURE

SUPERFÍCIE LAMINADA LAMINATED SURFACE - SURFACE STRATIFIÉE

ESP. Superficie de escritura verde en plancha laminada de alta presión (HPL). Extremadamente resistente a los impactos y desgaste. Fácil mantenimiento. No magnética.

ENG. Green writing surface in high pressure laminated board (HPL). Extremely resistant to impacts and usage. Easy maintenance. Not magnetic.

FRA. Superficie d'écriture vert en planche laminée à haute pression (HPL). Extrêmement résistante aux impacts et usure. Facile d'entretien. Non magnétique.



730 - ZENIT - 730/X

SUPERFÍCIE DE ACERO VITRIFICADO ENAMELLED SURFACE - SURFACE ÉMAILLÉE

ESP. Superficie de color en acero vitrificado formada por una lámina central de acero de 0,7 mm cubierta con un revestimiento delgado de esmalte, que se funde con el acero a 800°C. Fabricado con un 30% de acero reciclado. Reciclable al 99,9%. Garantía de por vida. Resistente a rayaduras, abrasión, productos químicos, fuego, bacterias y graffitis. Fácil mantenimiento. Mayor contraste de color. Visibilidad mejorada y óptima comodidad visual. Magnética.

ENG. Coloured surface in vitrified steel formed by a 0.7 mm steel core sheet covered with a thin coating of enamel, which melts with the steel at 800 ° C. Made with 30% recycled steel. Recyclable at 99.9%. Lifetime warranty. Resistant to scratches, abrasion, chemicals, fire, bacteria and graffiti. Easy maintenance. Higher color contrast. Improved visibility and optimum visual comfort. Magnetic.

FRA. Superficie de couleur en acier vitrifié formé par une tôle d'acier de 0,7mm recouverte d'un revêtement émaillé fondu à 800°C. Fabriqué avec 30% d'acier recyclé. Recyclable à 99,9%. Garantie à vie. Résistant aux rayures, abrasion, produits chimiques, feu, bactéries et graffitis. Facile d'entretien. Grand contraste de couleur. Visibilité améliorée et qualité visuel optimum. Magnétique.

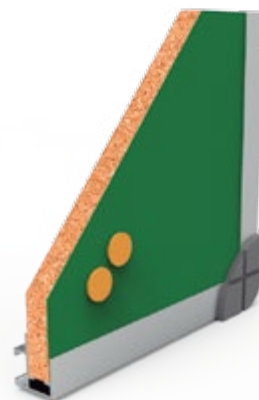

730/A - 730/C - 730/P - 734 - ZENIT - 730/D
730/T - 730/A/X - 739 - 730/VV - 730/G



La superficie e3 CeramicSteel es la única del sector a nivel mundial con la certificación:
Cradle to Cradle Certified TM Bronze

Norma ISO 9001



COLORES DE LA SUPERFICIE SURFACES COLOURS - COULEURS DE SURFACE

ESP. Colores disponibles para pizarras Escolplan de Planning Sislamo. Ideal para la escritura en tizas de colores o rotuladores de tiza líquida.

ENG. Colours available colors for Escoplan plan boards of Planning Sislamo. Ideal for writing with colored chalks or liquid chalk markers.

FRA. Couleurs disponibles pour tableaux Escolplan de Planning Sislamo. Idéal pour l'écriture à la craie de couleurs ou feutre de craie liquide.

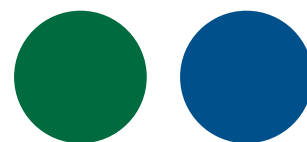

RAL 6028

RAL 5023

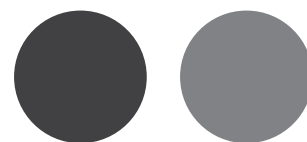

RAL 7015

RAL 7012

PERFIL DE LA SUPERFICIE SURFACES PROFILE - PROFIL DE SURFACE

ESP. Los perfiles que enmarcan las pizarras de Planning Sislamo son de aluminio anodizado. Las cantoneras, que ocultan el tornillo, son piezas fabricadas por inyección de ABS.

ENG. The profiles framing Planning Sislamo white boards are anodized aluminum. The corners, which conceal the screw, are manufactured by injection ABS.

FRA. Les profiles qui encadrent les tableaux Planning Sislamo sont en aluminum anodisé. Les coins, qui cachent la fixation, sont des pièces fabriquée par injection d'ABS.

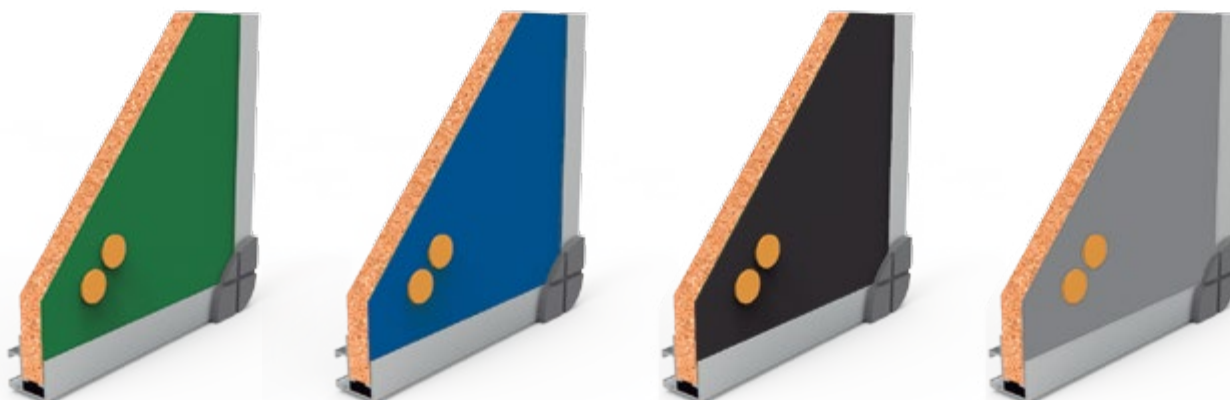
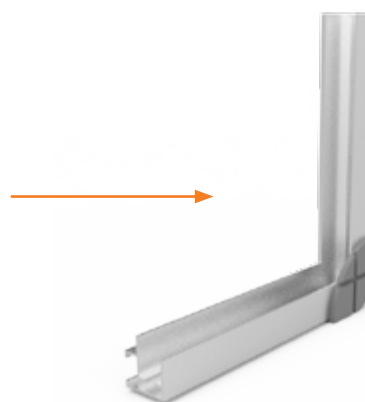

GUÍA PS

ESCOGE TU PIZARRA

CHOOSE YOUR WHITEBOARD - CHOISIR VOTRE TABLEAU

2-20

AULA PEQUEÑA

+20

AULA GRANDE

AULA PEQUEÑA CLASSROOM - ÉCOLE

ESP. Pizarras de uso personal para el uso en el hogar o en salas de pequeñas dimensiones. Disponibles en versión mural, con soportes, en diferentes materiales y colores.

ENG. Whiteboards for use in the home or in small rooms. Available in mural version, with supports, in varied materials and many colors.

FRA. Tableau à usage personnel pour la maison ou de petites pièces/bureaux.. Disponible en version murale, avec support et en différents matériaux et couleurs.

- **730**
- 730/A
- **730/C**
- **730/P**
- ZENIT
- 730/X
- 730/A/X

AULA GRANDE CLASSROOM - ÉCOLE

ESP. Pizarras para uso en escuelas, universidades o centros de enseñanza, con una altura de 120 cm y longitud variable. Se recomienda el uso de este tipo de pizarras debido a su medida ergonómica: tanto el punto superior como inferior coinciden con el punto de máxima extensión del brazo. Disponibles en versión mural, con soportes, en diferentes materiales y colores.

ENG. White boards for use in schools, universities or teaching , with a height of 120 cm and variable length. The use of this type of board is recommended due to its ergonomic measurement: both the upper and lower points coincide with the point of maximum extension of the arm. Available in mural version, with supports, in different materials and colours.

FRA. Tableaux pour usage en écoles, universités ou centres d'enseignement, avec une hauteur de 120 cm et longueur variable. Il est recommandé l'usage de ce type de tableaux pour leur dimensions ergonomiques: le point supérieurs et inférieure coincide avec le point maximum d'extension du bras. Disponibles en version murale, avec supports, en différents matériaux et couleurs.

- **730/A**
- ZENIT
- 730/X
- 730/A/X
- 730/D
- 730/T
- **730/VV**
- **730/C**

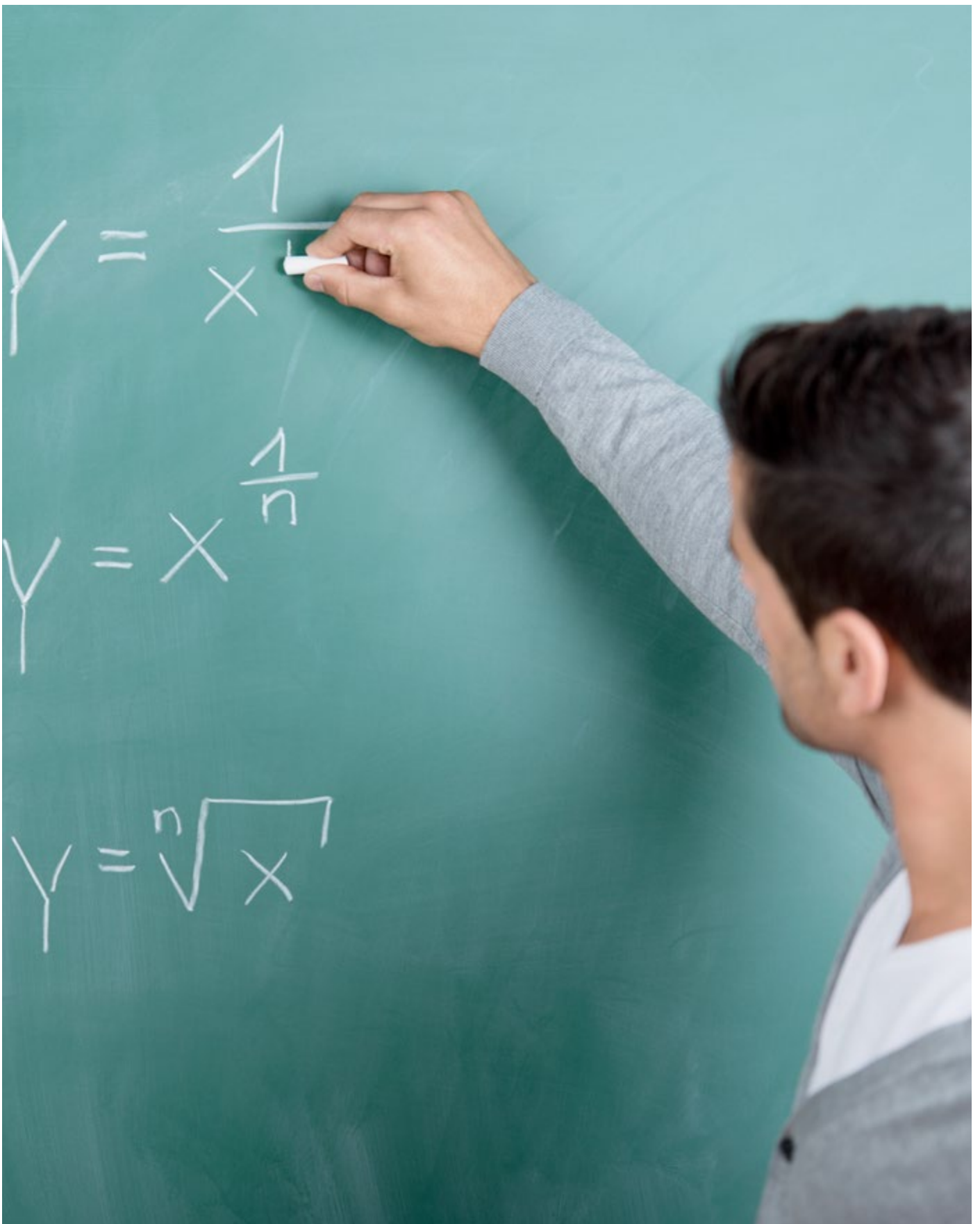

730

PIZARRA LAMINADA
LAMINATED CHALK BOARD - TABLEAU STRATIFIÉ



| REF | L | H | RAIL |
|---------|-----------|-----|------|
| 730/11 | 40 x 60 | 2.2 | 30 - |
| 730/12 | 60 x 80 | 2.2 | 30 - |
| 730/1 | 80 x 120 | 2.2 | 30 ✓ |
| 730/2 | 100 x 120 | 2.2 | 30 ✓ |
| 730/3 | 120 x 150 | 2.2 | 30 ✓ |
| 730/4 | 120 x 200 | 2.2 | 30 - |
| 730/5 | 120 x 250 | 2.2 | 30 - |
| 730/6 | 120 x 300 | 2.2 | 30 - |
| 730/7* | 120 x 350 | 2.2 | 30 - |
| 730/8* | 120 x 400 | 2.2 | 30 - |
| 730/9* | 120 x 500 | 2.2 | 30 - |
| 730/10* | 120 x 600 | 2.2 | 30 - |

* Fabricado en dos piezas
Made from 2 pieces
Fabriqué en 2 pièces

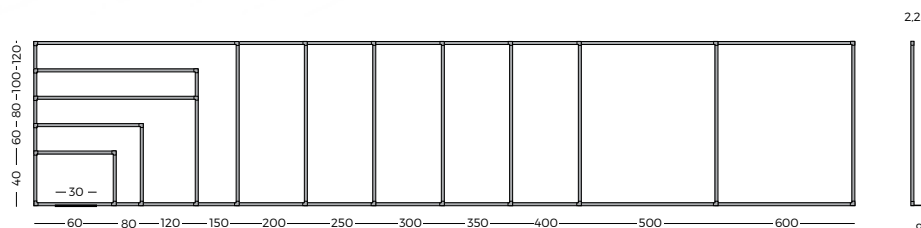

PIZARRA LAMINADA

ESP. Pizarra laminada verde. Superficie laminada en alta presión. Enmarcada con perfil de aluminio anodizado en color plata mate y cantoneras redondeadas de plástico gris. Escritura con tiza. Incluye cajetín reposarrotuladores de 30 cm.

LAMINATED CHALKBOARD

ENG. High-pressure laminated chalkboard. Equipped with silver anodized aluminium frame and grey plastic rounded corners. Suitable for writing with chalk. A 30 cm. pen tray included.

TABLEAU STRATIFIÉ

FRA. Tableau stratifié vert. Encadrement en aluminium anodisé couleur argent aux coins arrondis en plastique gris. Surface pour écriture à la craie. Livré avec un auget porte marqueurs de 30 cm.



SOPORTE T

| REF | ↑ | L | ⊥ | □ |
|--------------|-----|-----------|----|----|
| 736/L | 190 | 120 x 150 | 53 | 30 |
| 737/L | 190 | 120 x 200 | 53 | 30 |



SOPORTE DELTA

| REF | ↑ | L | ⊥ | □ |
|--------------|-----|-----------|----|----|
| 738/L | 190 | 120 x 150 | 53 | 30 |
| 739/L | 190 | 120 x 200 | 53 | 30 |



SOPORTE Y2

| REF | ↑ | L | ⊥ | □ |
|-----------------|-----|-----------|----|----|
| + Y2/120 | 190 | 100 x 120 | 53 | 30 |
| + Y2/150 | 190 | 120 x 150 | 53 | 30 |
| + Y2/200 | 190 | 120 x 200 | 53 | 30 |

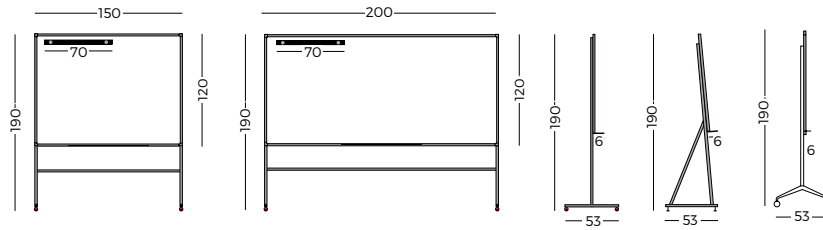

PS Capture

App by Planning Sislamo
www.planningsislamo.com/pscapture



ACCESORIOS

7006



7014



7008



730/A

PIZARRA DE ACERO VITRIFICADO
ENAMELLED CHALK BOARD - TABLEAU EMAILLÉ



| REF | L | H | RAIL | RAIL |
|--------|-----------|-----|------|------|
| 730/A1 | 120 x 100 | 2.2 | 30 | ✓ |
| 730/A2 | 120 x 150 | 2.2 | 30 | ✓ |
| 730/A3 | 120 x 200 | 2.2 | 30 | - |
| 730/A4 | 120 x 250 | 2.2 | 30 | - |
| 730/A5 | 120 x 300 | 2.2 | 30 | - |
| 730/A6 | 120 x 400 | 2.2 | 30 | - |



COLOR

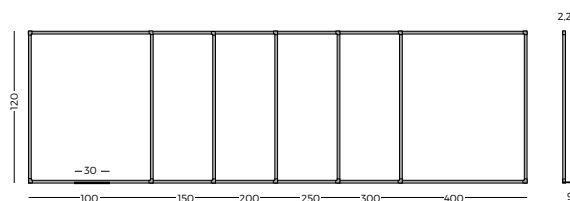

PIZARRA DE ACERO VITRIFICADO

ESP. Pizarra mural de acero vitrificado verde. Enmarcada con perfil de aluminio anodizado en color plata mate. Superficie de acero vitrificado a 800°C con garantía de por vida. Escritura con tiza. Magnética. Incluye cajetín de 30 cm.

ENAMELLED CHALKBOARD

ENG. Enamelled chalkboard. Equipped with silver anodized aluminium frame and plastic rounded corners. Surface enamelled at 800°C. Suitable for writing with chalk. Magnetic. 30 cm en tray included. Lifetime warranty on the writing surface.

TABLEAU EMAILLÉ

FRA. Tableau émaillé vert. Encadrement en aluminium anodisé couleur argent aux coins arrondis en plastique. Surface émaillée vitrifiée à 800°C. Livré avec auget porte marqueurs de 30 cm. Magnétique. Superficie garantie à vie. Surface pour écriture à la craie.



SOPORTE T

| REF | ↑ | └┘ | ┆┆ | ┆ |
|--------------|-----|-----------|----|----|
| 736/A | 190 | 120 x 150 | 53 | 30 |
| 737/A | 190 | 120 x 200 | 53 | 30 |



SOPORTE DELTA

| REF | ↑ | └┘ | ┆┆ | ┆ |
|--------------|-----|-----------|----|----|
| 738/A | 190 | 120 x 150 | 53 | 30 |
| 739/A | 190 | 120 x 200 | 53 | 30 |



SOPORTE Y2

| REF | ↑ | └┘ | ┆┆ | ┆ |
|-----------------|-----|-----------|----|----|
| + Y2/120 | 190 | 100 x 120 | 53 | 30 |
| + Y2/150 | 190 | 120 x 150 | 53 | 30 |
| + Y2/200 | 190 | 120 x 200 | 53 | 30 |

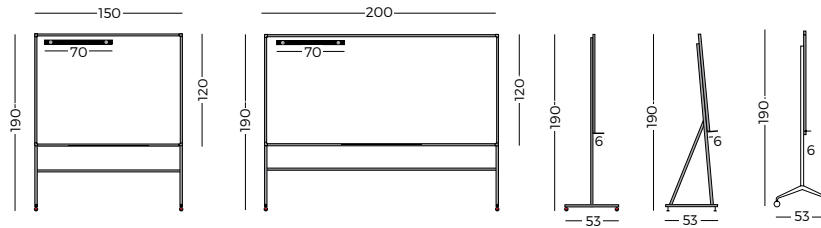

PS Capture

App by Planning Sislamo
www.planningsislamo.com/pscapture



ACCESORIOS

7006



7013/C



7013/B



730/C-730/P

PIZARRA DE ACERO VITRIFICADO CON CUADRICULA/PENTAGRAMA
 GRID/PENTAGRAM - QUADRILLÉ/PENTAGRAMME

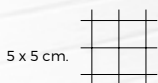
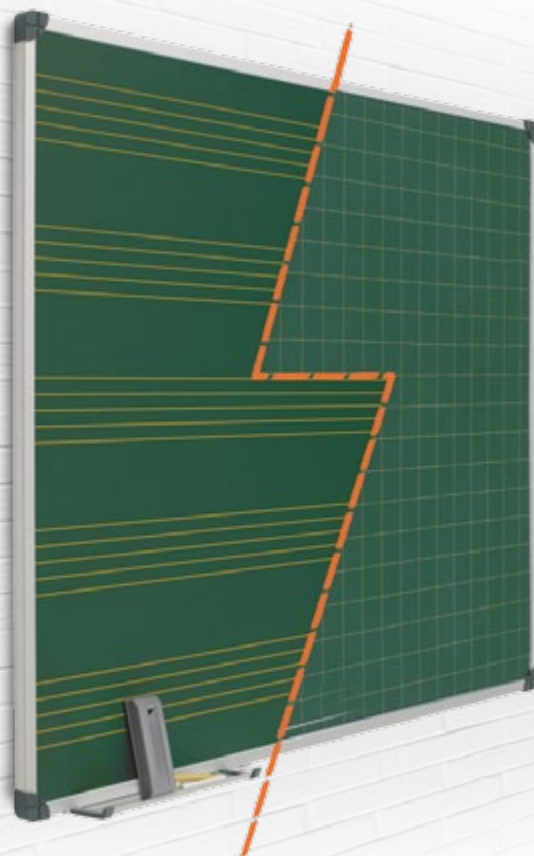
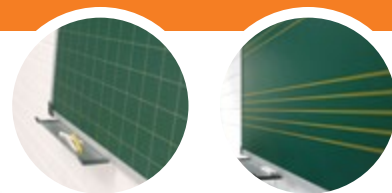

| REF | L | H | RAIL |
|-----------------|-----------|-----|------|
| 730/A/C1 | 100 x 120 | 2.2 | 30 ✓ |
| 730/A/C2 | 120 x 150 | 2.2 | 30 ✓ |
| 730/A/C3 | 120 x 200 | 2.2 | 30 - |
| 730/A/C4 | 120 x 300 | 2.2 | 30 - |

| REF | L | H | RAIL |
|-----------------|-----------|-----|------|
| 730/A/P1 | 120 x 150 | 2.2 | 30 ✓ |
| 730/A/P2 | 120 x 200 | 2.2 | 30 - |
| 730/A/P3 | 120 x 300 | 2.2 | 30 - |

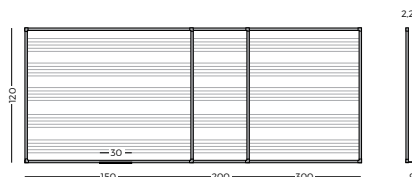
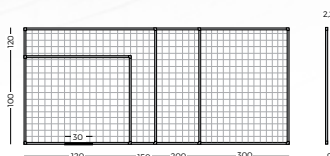

PIZARRA CUADRICULADA/PENTAGRAMA

ESP. Pizarra mural de acero vitrificado verde con cuadrícula o pentagrama. Enmarcada con perfil de aluminio anodizado en color plata mate. Superficie de acero vitrificado a 800°C con garantía de por vida. Escritura con tiza. Magnética. Incluye cajetín de 30 cm.

GRIDED/PENTAGRAM WHITEBOARD

ENG. Enamelled grided or pentagram chalkboard. Equipped with silver anodized aluminium frame and plastic rounded corners. Surface enamelled at 800°C. Suitable for writing with chalk. Magnetic. 30 cm en tray included. Lifetime warranty on the writing surface.

TABLEAU QUADRILLÉ/PENTAGRAMME

FRA. Tableau émaillé vert quadrillé ou pentagramme Encadrement en aluminium anodisé couleur argent aux coins arrondis en plastique. Surface émaillée vitrifiée à 800°C. Livré avec auget porte marqueurs de 30 cm. Magnétique. Superficie garantie à vie. Surface pour écriture à la craie.



SOPORTE T

| REF | ↑ | L | ⇄ | □ |
|------------------|-----|-----------|----|----|
| 730/AC/T2 | 190 | 120 x 150 | 53 | 30 |
| 730/AC/T3 | 190 | 120 x 200 | 53 | 30 |
| 736/A/P2 | 190 | 120 x 150 | 53 | 30 |
| 737/A/P3 | 190 | 120 x 200 | 53 | 30 |



SOPORTE DELTA

| REF | ↑ | L | ⇄ | □ |
|------------------|-----|-----------|----|----|
| 730/AC/D2 | 190 | 120 x 150 | 53 | 30 |
| 730/AC/D3 | 190 | 120 x 200 | 53 | 30 |
| 738/A/P2 | 190 | 120 x 150 | 53 | 30 |
| 739/A/P3 | 190 | 120 x 200 | 53 | 30 |



SOPORTE Y2

| REF | ↑ | L | ⇄ | □ |
|-----------------|-----|-----------|----|----|
| + Y2/150 | 190 | 120 x 150 | 53 | 30 |
| + Y2/200 | 190 | 120 x 200 | 53 | 30 |

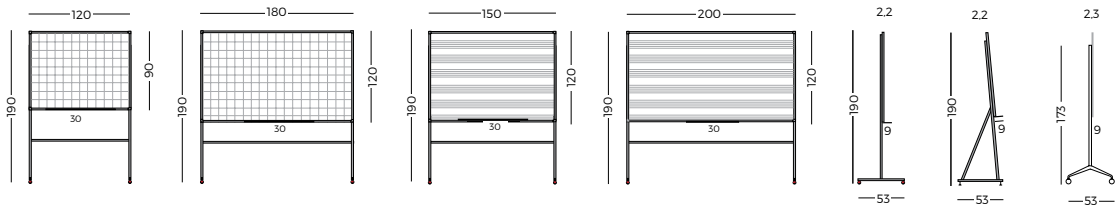

PS Capture
App by Planning Sislamo
www.planningsislamo.com/pscapture



ACCESORIOS

7006



7013/C



7013/B



734

PIZARRA DE ACERO VITRIFICADO CON MARCO 'MINI'
WHITEBOARD 'MINI' - TABLEAU 'MINI'

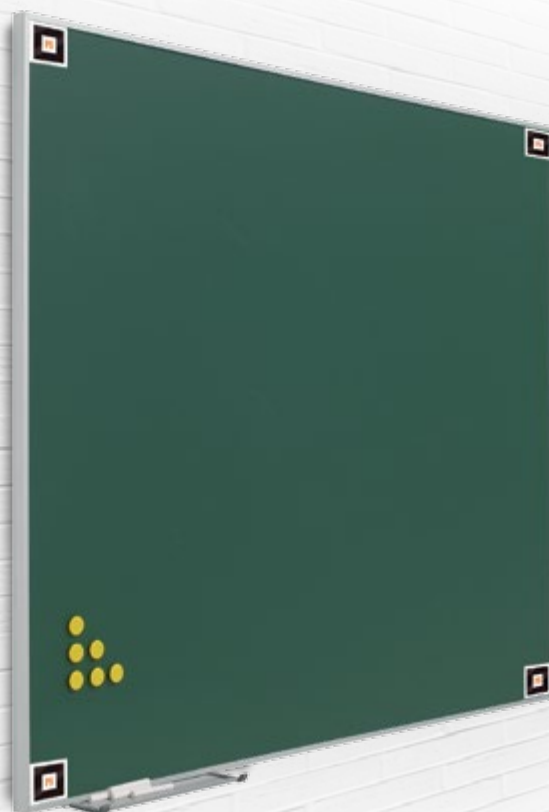

| REF | L | H | RAIL | |
|--------|-----------|-----|------|---|
| 734/10 | 40 x 60 | 2.2 | 30 | - |
| 734/1 | 60 x 80 | 2.2 | 30 | - |
| 734/2 | 80 x 100 | 2.2 | 30 | ✓ |
| 734/3 | 100 x 120 | 2.2 | 30 | ✓ |
| 734/4 | 120 x 150 | 2.2 | 30 | ✓ |
| 734/5 | 120 x 200 | 2.2 | 30 | - |
| 734/6 | 120 x 250 | 2.2 | 30 | - |



COLOR



/VD /AZ /NG /GR

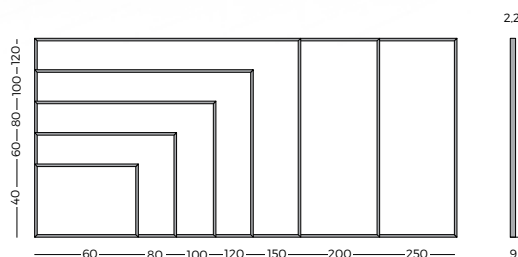

PIZARRA DE ACERO VITRIFICADO 'MINI'

ESP. Pizarra mural de acero vitrificado verde. Enmarcada con perfil de aluminio anodizado Mini en color plata mate. Superficie de acero vitrificado a 800°C con garantía de por vida. Escritura con tiza. Magnética. Incluye cajetín de 30 cm.

ENAMELLED CHALK BOARD 'MINI'

ENG. Enamelled chalkboard. Equipped with Mini silver anodized aluminium frame and mitred corners. Surface enamelled at 800°C. Suitable for writing with chalk. Magnetic. 30 cm en tray included. Lifetime warranty on the writing surface.

TABLEAU ÉMAILLÉ 'MINI'

FRA. Tableau émaillé vert. Encadrement Mini en aluminium anodisé couleur argent. Surface émaillée vitrifiée à 800°C. Livré avec auget porte marqueurs de 30 cm. Magnétique. Superficie garantie à vie. Écriture à la craie.



SOPORTE T

| REF | ↑ | L | ⇄ | □ |
|---------------|-----|-----------|----|----|
| 734/T2 | 190 | 100 x 80 | 53 | 30 |
| 734/T3 | 190 | 100 x 120 | 53 | 30 |
| 734/T4 | 190 | 120 x 150 | 53 | 30 |
| 734/T5 | 190 | 120 x 200 | 53 | 30 |



SOPORTE DELTA

| REF | ↑ | L | ⇄ | □ |
|---------------|-----|-----------|----|----|
| 734/D2 | 190 | 100 x 80 | 53 | 30 |
| 734/D3 | 190 | 100 x 120 | 53 | 30 |
| 734/D4 | 190 | 120 x 150 | 53 | 30 |
| 734/D5 | 190 | 120 x 200 | 53 | 30 |



SOPORTE Y2

| REF | ↑ | L | ⇄ | □ |
|-----------------|-----|-----------|----|----|
| + Y2/80 | 190 | 100 x 80 | 53 | 30 |
| + Y2/120 | 190 | 100 x 120 | 53 | 30 |
| + Y2/150 | 190 | 120 x 150 | 53 | 30 |
| + Y2/200 | 190 | 120 x 200 | 53 | 30 |

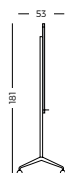
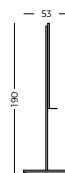
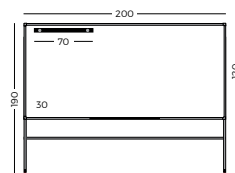
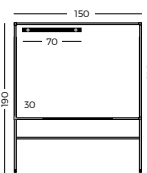
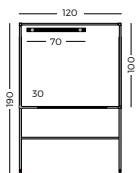
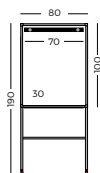

PS Capture

App by Planning Sisplamo
www.planningsisplamo.com/pscapture



ACCESORIOS

7006



7013/C



7013/B



ZENIT

PIZARRA ZENIT DE ACERO VITRIFICADO/LAMINADA
ENAMELLED/LAMINATED WHITEBOARD - TABLEAU ÉMAILLÉ/STRATIFIÉ



COLOR



| REF | L | H | RAIL |
|----------|-----------|-----|------|
| Z/730/A0 | 80 x 100 | 2,3 | 30 ✓ |
| Z/730/A1 | 100 x 120 | 2,3 | 30 ✓ |
| Z/730/A2 | 120 x 150 | 2,3 | 30 ✓ |
| Z/730/A3 | 120 x 200 | 2,3 | 30 - |
| Z/730/A4 | 120 x 250 | 2,3 | 30 - |
| Z/730/A5 | 120 x 300 | 2,3 | 30 - |



| REF | L | H | RAIL |
|---------|-----------|-----|------|
| Z/730/0 | 80 x 120 | 2,3 | 30 ✓ |
| Z/730/1 | 100 x 150 | 2,3 | 30 ✓ |
| Z/730/2 | 120 x 150 | 2,3 | 30 ✓ |
| Z/730/3 | 120 x 200 | 2,3 | 30 - |
| Z/730/4 | 120 x 250 | 2,3 | 30 - |
| Z/730/5 | 120 x 300 | 2,3 | 30 - |

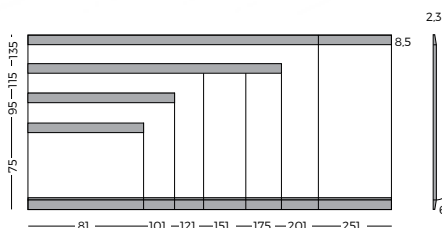

PIZARRA ZENIT

ESP. Pizarra mural Zenit de acero vitrificado o laminada verde. Enmarcada con perfil de aluminio anodizado en color plata mate. Superficie de acero vitrificado a 800°C con garantía de por vida. Escritura con tiza. Incluye cajetín de 30 cm.

ZENIT WHITEBOARD

ENG. Enamelled/laminated Zenit chalkboard. Equipped with silver anodized aluminium frame and plastic rounded corners. Surface enamelled at 800°C. Suitable for writing with chalk. 30 cm en tray included. Lifetime warranty on the writing surface.

TABLEAU ZENIT

FRA. Tableau en acier émaillé ou stratifié vert. Encadrement en aluminium anodisé couleur argent aux coins arrondis en plastique. Surface émaillée vitrifiée à 800°C. Livré avec auget porte marqueurs de 30 cm. Surface garantie à vie. Écriture à la craie.

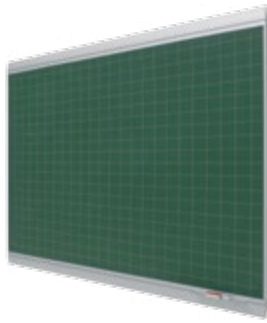

CUADRÍCULA

| REF | L | H | P |
|------------|-----------|-----|----|
| Z/730/A/C1 | 100 x 120 | 2.3 | 30 |
| Z/730/A/C2 | 120 x 150 | 2.3 | 30 |
| Z/730/A/C3 | 120 x 200 | 2.3 | 30 |
| Z/730/A/C4 | 120 x 300 | 2.3 | 30 |

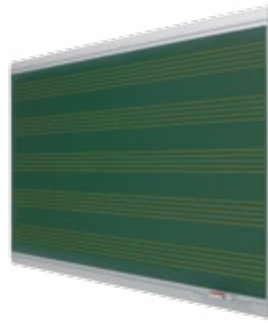

PENTAGRAMA

| REF | L | H | P |
|------------|-----------|-----|----|
| Z/730/A/P1 | 120 x 150 | 2.3 | 30 |
| Z/730/A/P2 | 120 x 200 | 2.3 | 30 |
| Z/730/A/P3 | 120 x 300 | 2.3 | 30 |



SOPORTE Y2

| REF | H | L | H | P |
|------------|-----|-----------|----|----|
| Z/730/A/Y0 | 190 | 100 x 80 | 53 | 30 |
| Z/730/A/Y1 | 190 | 100 x 120 | 53 | 30 |
| Z/730/A/Y2 | 190 | 100 x 150 | 53 | 30 |
| Z/730/A/Y3 | 190 | 120 x 200 | 53 | 30 |

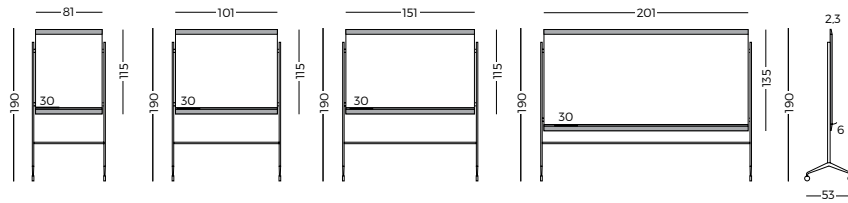

PS Capture
App by Planning Sisplamo
www.planningsisplamo.com/pscapture

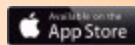

ACCESORIOS

7015



7013/C







Z/7017







730/D - 730/T

PIZARRA DÍPTICA/TRÍPTICA
 DOUBLE/TRIPLE CHALKBOARD -
 TABLEAU DIPTYQUE/TRIPTYQUE



| REF |  |  |  |  |
|---------------|-------------------------------------------------------------------------------------|-------------------------------------------------------------------------------------|-------------------------------------------------------------------------------------|-------------------------------------------------------------------------------------|
| 730/D1 | 90 x 120 | 90 x 60 | 2+2 | 30 |
| 730/D2 | 120 x 180 | 120 x 90 | 2+2 | 30 |

| REF |  |  |  |  |
|---------------|---------------------------------------------------------------------------------------|---------------------------------------------------------------------------------------|---------------------------------------------------------------------------------------|---------------------------------------------------------------------------------------|
| 730/T1 | 90 x 240 | 90 x 120 | 2+4 | 30 |
| 730/T2 | 120 x 400 | 120 x 200 | 2+4 | 30 |

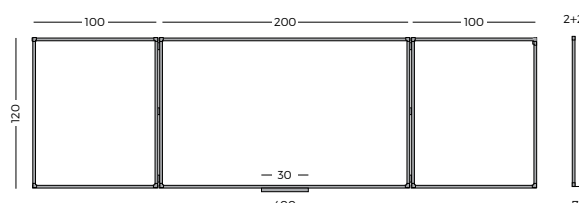
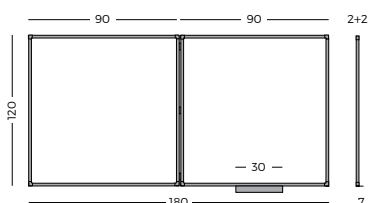

PIZARRA DÍPTICA/TRÍPTICA

ESP. Pizarra díptica o tríptica de acero vitrificado verde. Enmarcada con perfil de aluminio anodizado en color plata mate y cantoneras redondeadas de plástico gris. Superficie de acero vitrificado a 800°C. Escritura con tiza. Magnética. Cajetín de 30 cm. incluido. 3 o 5 superficies de escritura.

DOUBLE/TRIPLE CHALKBOARD

ENG. Double or triple enamelled chalkboard. Equipped with silver anodized aluminium frame and grey plastic rounded corners. Surface enamelled at 800°C. Suitable for writing with chalk. Magnetic. 30 cm. pen tray included. 3 or 5 writing surfaces

TABLEAU DIPTYQUE/TRIPTYQUE

FRA. Tableau diptyque ou triptyque vert en acier émaillé. Cadre en aluminium anodisé couleur argent aux coins arrondis en plastique gris. Surface émaillée vitrifiée à 800°C. Effaçable à la craie. Magnétique. Livré avec un auget de 30 cm. 3 ou 5 surfaces d'écriture.



730/X - 730/A/X

PIZARRA VERDE VOLTEABLE
REVOLVING CHALKBOARD - TABLEAU VERT PIVOTANT



| REF | ↑ | L | HT | □ |
|-----------------|-----|-----------|----|-----|
| 730/A/X1 | 210 | 120 x 150 | 53 | 100 |
| 730/A/X2 | 210 | 120 x 175 | 53 | 100 |
| 730/A/X3 | 210 | 120 x 200 | 53 | 100 |

| REF | ↑ | L | HT | □ |
|---------------|-----|-----------|----|-----|
| 730/X1 | 210 | 120 x 150 | 53 | 100 |
| 730/X2 | 210 | 120 x 175 | 53 | 100 |
| 730/X3 | 210 | 120 x 200 | 53 | 100 |

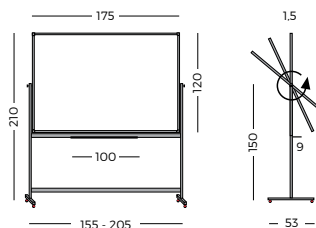

PIZARRA VOLTEABLE

ESP. Pizarra volteable de doble cara laminada o de acero vitrificado verde. Enmarcada con perfil de aluminio anodizado en color plata mate y cantoneras redondeadas de plástico gris. Escritura con tiza. Estructura volteable metálica móvil provista de 4 ruedas, 2 de ellas con freno.

REVOLVING CHALKBOARD

ENG. Revolving double sided enamelled or laminated chalkboard. Equipped with silver anodized aluminium frame and grey plastic rounded corners. Suitable for writing with chalk. Metallic moveable support equipped with 4 castors, 2 of them with brakes.

TABLEAU PIVOTANT

FRA. Tableau double surface émaillée ou stratifiée vert rotatif. Encadrement en aluminium anodisé argent aux coins arrondis en plastique gris. Monté sur piétement. Écriture à la craie. Support métallique équipé de 4 roulettes, dont deux à freins.

720/VV

PIZARRA DE VAIVÉN
VAIVÉN BOARD - TABLEAU VA-ET-VIENT

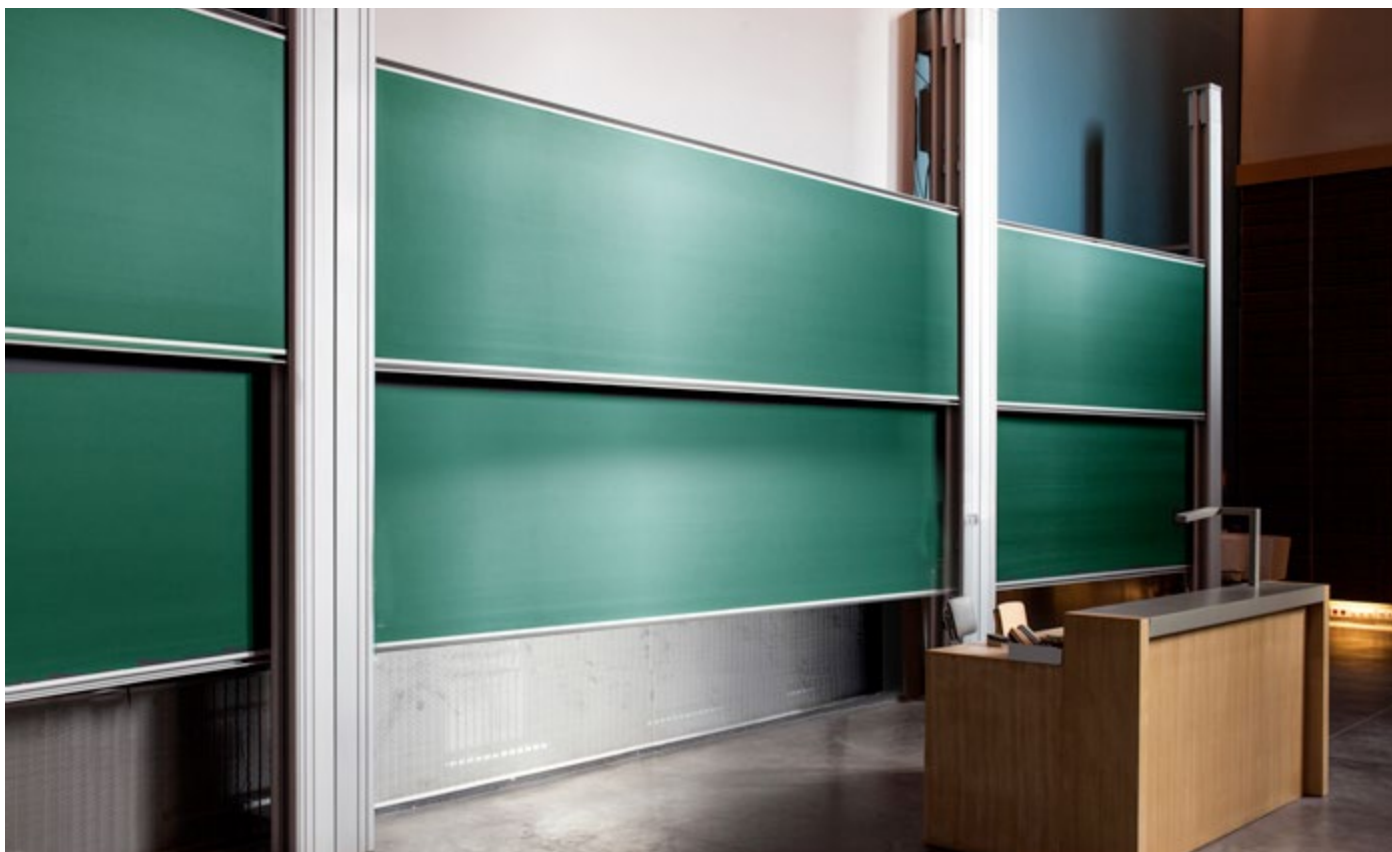

| REF | | L | H |
|-----------|---|-----------|----|
| 730/2/VV1 | x | 120 x 200 | 12 |
| 730/2/VV2 | x | 120 x 250 | 12 |
| 730/2/VV3 | x | 120 x 300 | 12 |
| 730/2/VV4 | x | 120 x 400 | 12 |



COLOR

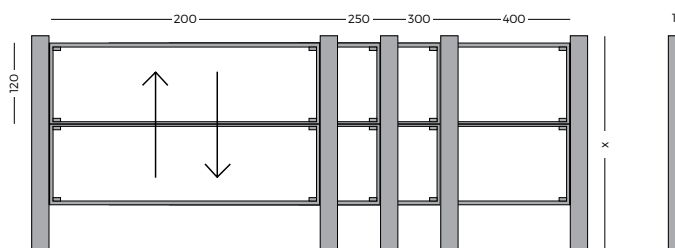

PIZARRA VAIVÉN

ESP. Pizarra de acero vitrificado verde sobre una estructura de aluminio anodizado en plata mate montada sobre suelo y pared. La pizarra se desliza y va guiada en el perfil por rodamientos de nylon. Ideales para colegios, universidades, anfiteatros...

WHITEBOARD VAIVEN

ENG. Enamelled chalkboard mounted upon a supporting structure in silver anodized aluminium on stand or wall fixation. The surface slide is guided through a cable transmission. The ideal communication tool for large scale presentations, lecture theatres...

TABLEAU VA-ET-VIENT

FRA. Tableau vert émaillé monté sur une structure en aluminium anodisé couleur argent, fixation sol et mur. La surface se déplace sur le profil via des roulements. Pour une communication idéale dans les amphithéâtres, salles de congrès...



730/GG

PIZARRA DE GUILLOTINA
GUILLOTINE BOARD - TABLEAU GUILLOTINE



COLOR



/VD /AZ /NG /GR

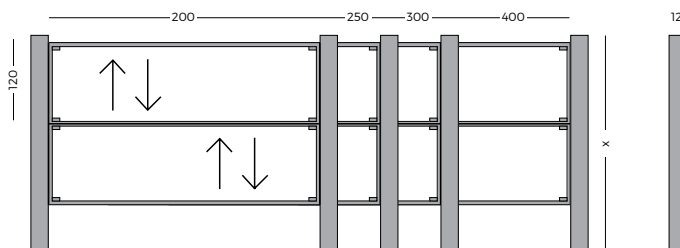

| REF | | L | H |
|-----------|---|-----------|----|
| 730/A2/G1 | x | 120 x 200 | 12 |
| 730/A2/G2 | x | 120 x 250 | 12 |
| 730/A2/G3 | x | 120 x 300 | 12 |
| 730/A2/G4 | x | 120 x 400 | 12 |



PIZARRA GUILLOTINA

ESP. Conjunto de 2 pizarras verdes de acero vitrificado sobre una estructura de aluminio anodizado en plata mate montadas sobre suelo y pared. Las pizarras son independientes entre sí, guiadas por rodamiento de nylon.

GUILLOTINE BOARD

ENG. 2 enamelled chalkboards mounted upon a supporting structure in silver anodized aluminium on stand or wall fixation. Both writing surfaces slide vertically and are interdependent or each other. Guidance by nylon castors.

TABLEAU GUILLOTINE

FRA. Ensemble de 2 tableaux verts émaillés montés sur une structure en aluminium anodisé couleur argent, fixation sol et mur. Les deux surfaces se déplacent de façon indépendantes et sont guidées par des roulements.

ACCESORIOS

ACCESORIOS
ACCESORIES - ACCESSOIRES



7015

ESP. Borrador magnético "Design"
ENG. Magnetic eraser "Design"
FRA. Effaceur magnetique "Design"



7015/1

5 u.

ESP. Recambio para borrador 7015
ENG. 7015 eraser felt refills
FRA. Feutrines pour effaceur 7015



7014

ESP. Borrador de plástico
ENG. Plastic eraser
FRA. Effaceur en plastique



7014/1

2 u.

ESP. Recambio para borrador 7014
ENG. 7014 eraser felt refills
FRA. Feutrines pour effaceur 7014



7006

ESP. Borrador de aluminio magnético
ENG. Magnetic eraser
FRA. Effaceur magnetique



7012

ESP. Borrador de aluminio
ENG. Eraser
FRA. Effaceur



7006/1

20 u.

ESP. Recambio para borrador 7006 y 7012
ENG. 7006 and 7012 eraser felt refills
FRA. Feutrines pour effaceur 7006 et 7012



7003 - 7003/30

ESP. Cajetín de aluminio de 100 ó 30 cm.
ENG. 100 or 30 cm. aluminium pen tray
FRA. Porte-marqueurs 100 ou 30 cm.



7013/B

12 u.

ESP. Tizas blancas
ENG. White chalk
FRA. Craies blanches

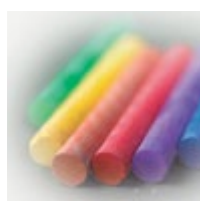

7013/C

12 u.

ESP. Tizas de colores
ENG. Colour chalks
FRA. Craies de couleurs



BL/ES/0061

3 u.

ESP. Tinta líquida blanca
ENG. White liquid ink
FRA. Encre blanche liquide



BL/ES/0062

5 u.

ESP. Tinta líquida de colores
ENG. Colour liquid ink
FRA. Couleurs d'encre liquide



PS Capture

by Planning Sislamo

Capta, clasifica y comparte el contenido de tu pizarra.
Capture, classify and share the content of your board.
Capturez, ordenez et partagez le contenu de votre tableau.



planningsislamo.com/pscapture



INFORMPLAN

TABLEROS DE INFORMACIÓN
BULLETIN BOARDS
TABLEAUX D'INFORMATION

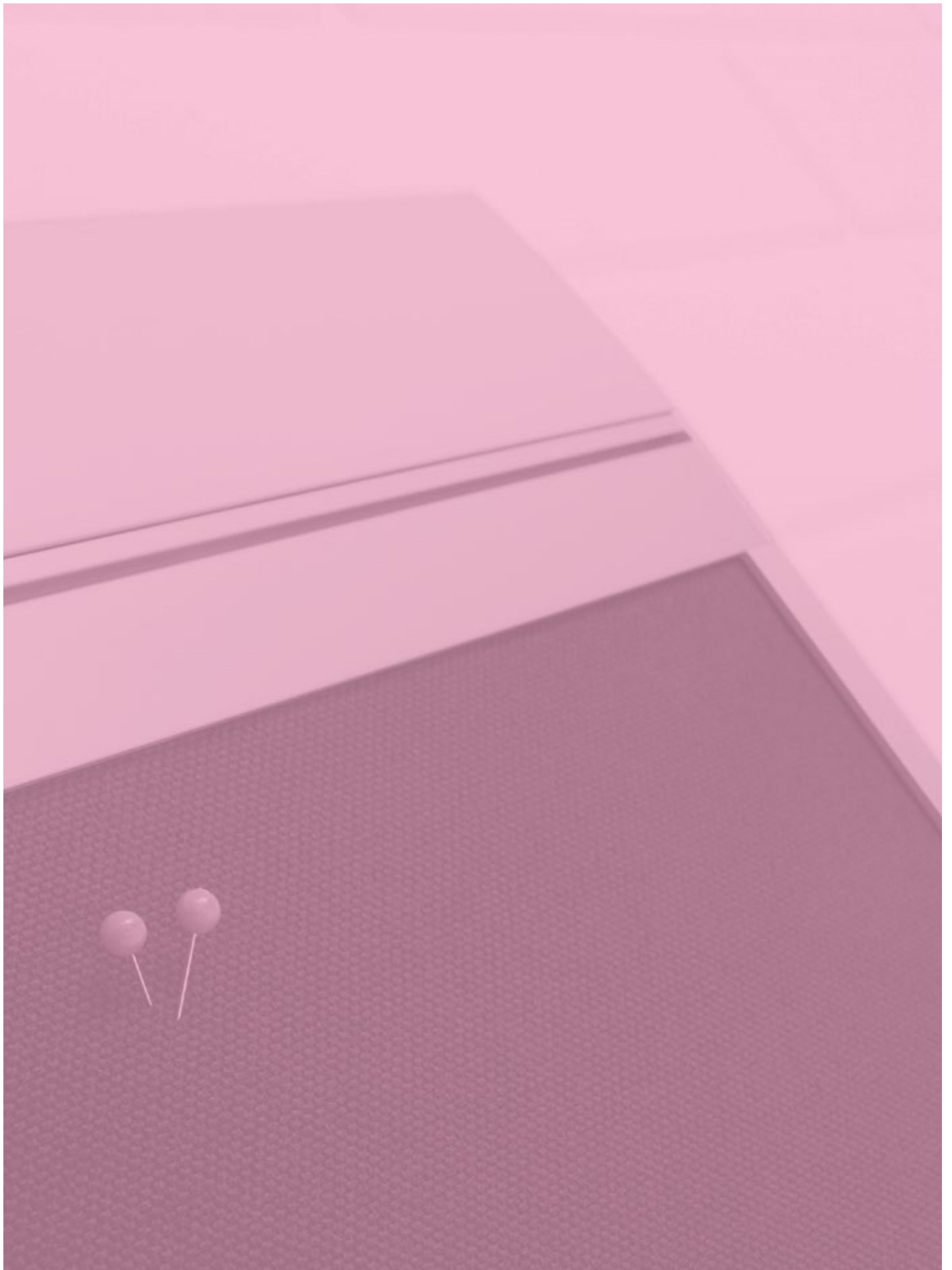

BASIC

TABLERO DE CORCHO
CORK BOARD - TABLEAU FOND LIÈGE



| REF | L | H |
|------------|-----------|---|
| BL/IN/0101 | 45 x 60 | 1 |
| BL/IN/0102 | 60 x 90 | 1 |
| BL/IN/0103 | 90 x 120 | 1 |
| BL/IN/0114 | 100 x 150 | 1 |

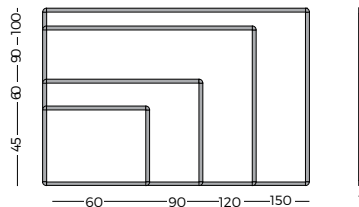

TABLERO DE CORCHO

ESP. Tablero de corcho natural de 1 cm. de espesor, con marco de aluminio anodizado en plata mate y cantoneras redondeadas de plástico gris. Disponible en 4 formatos.

CORK BOARD

ENG. Natural cork board (1 cm.) with anodized aluminum frame in matt silver with rounded corners made from gray plastic. Available in 4 formats.

TABLEAU FOND LIÈGE

FRA. Tableau en liège naturel (1 cm.) avec cadre en aluminium anodisé couleur argent mate et coins arrondis en plastique gris. Disponible en 4 formats.



CORK

ROLLO DE CORCHO
ROLLER CORK - ROULEAU DE LIÈGE



ACABADO



CORK

| REF | L | H | U. |
|-----|---------|-----|----|
| 767 | 30 x 40 | 0,5 | 4 |



COLOR



/0320 /0321 /0322 /0323 /0324 /0325 /0326

| REF A | L | REF B | L | H | U. |
|-------------------|---------|-------------------|----------|-----|----|
| BL/IN/0320 | 40 x 50 | BL/IN/0420 | 48 x 300 | 0,4 | 1 |
| BL/IN/0321 | 40 x 50 | BL/IN/0421 | 48 x 300 | 0,4 | 1 |
| BL/IN/0322 | 40 x 50 | BL/IN/0422 | 48 x 300 | 0,4 | 1 |
| BL/IN/0323 | 40 x 50 | BL/IN/0423 | 48 x 300 | 0,4 | 1 |
| BL/IN/0324 | 40 x 50 | BL/IN/0424 | 48 x 300 | 0,4 | 1 |
| BL/IN/0325 | 40 x 50 | BL/IN/0425 | 48 x 300 | 0,4 | 1 |
| BL/IN/0326 | 40 x 50 | BL/IN/0426 | 48 x 300 | 0,4 | 1 |



CORCHO ADHESIVO

ESP. Corcho autoadhesivo de entre 4 y 5 mm de grosor. Fácil instalación. Disponible en láminas de corcho natural y láminas o rollo de corcho pintado en 7 colores diferentes. Ideal tanto para uso doméstico como para la oficina.

ADHESIVE CORK

ENG. Self-adhesive cork panels, between 4 and 5 mm thick. Easy installation. Available as a panel in colour or natural and as a roll only in colour. Ideal both for domestic use and for the office.

LIÈGE ADHÉSIF

FRA. Liège auto-adhésif de 4 à 5 mm d'épaisseur. Installation facile. Disponible en feuilles de liège ou rouleau, finitions naturelles ou peints de 7 couleurs différentes. Idéal à la fois pour un usage domestique ou pour le bureau.

765

TABLERO DE CORCHO
CORK BOARD - TABLEAU FOND LIÈGE



| REF | L | H | RAIL |
|--------|-----------|-----|------|
| 765/10 | 40 x 60 | 2.2 | - |
| 765/1 | 60 x 80 | 2.2 | - |
| 765/2 | 80 x 100 | 2.2 | ✓ |
| 765/3 | 100 x 120 | 2.2 | ✓ |
| 765/4 | 100 x 150 | 2.2 | ✓ |
| 765/5 | 100 x 175 | 2.2 | ✓ |
| 765/6 | 100 x 200 | 2.2 | - |
| 765/7 | 100 x 250 | 2.2 | - |

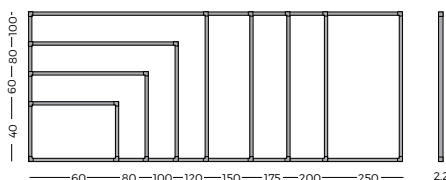

TABLERO DE CORCHO

ESP. Tablero de anuncios mural con base de corcho natural, enmarcado con perfil de aluminio anodizado en color plata mate y cantoneras redondeadas de plástico gris. Se pueden fijar sobre su superficie notas, avisos, etc. mediante agujas. Corcho de 5 mm. de grosor.

CORK BOARD

ENG. Cork board equipped with silver anodized aluminium frame and grey plastic rounded corners. Ideal for pinning notes, notices, posters etc. Cork thickness: 5 mm.

TABLEAU FOND LIÈGE

FRA. Tableau d'affichage en liège avec encadrement en aluminium anodisé couleur argent, coins arrondis en plastique gris. Idéal pour l'affichage de notes, avis, posters, etc... par épingles et punaises. Liège de 5 mm de très bonne qualité.



SOPORTE T

| REF | ↑ | └ | ┆┆ |
|----------------|-----|-----------|----|
| 765/2/T | 190 | 100 x 80 | 53 |
| 765/3/T | 190 | 100 x 120 | 53 |
| 765/4/T | 190 | 120 x 150 | 53 |
| 765/6/T | 190 | 120 x 200 | 53 |



SOPORTE DELTA

| REF | ↑ | └ | ┆┆ |
|----------------|-----|-----------|----|
| 765/2/D | 190 | 100 x 80 | 53 |
| 765/3/D | 190 | 100 x 120 | 53 |
| 765/4/D | 190 | 120 x 150 | 53 |
| 765/6/D | 190 | 120 x 200 | 53 |



SOPORTE Y2

| REF | ↑ | └ | ┆┆ |
|-----------------|-----|-----------|----|
| + Y2/120 | 190 | 100 x 120 | 53 |
| + Y2/150 | 190 | 100 x 150 | 53 |
| + Y2/200 | 190 | 100 x 200 | 53 |

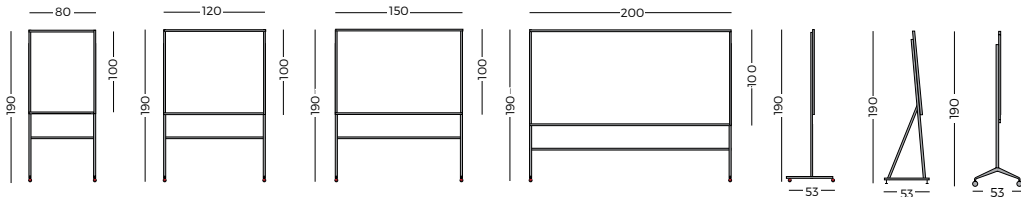

PERSONALIZACIÓN: 765 + ...

| REF | └ | ┆┆ |
|---------------|-----------|-----|
| A4/M | 24,5 x 22 | 3,5 |
| A5/M | 16,5 x 16 | 3,5 |
| A4/3/M | 16,5 x 11 | 3,5 |

Disponible para Ref. 760
 Available also for Ref. 760
 Disponible par Ref. 760



760

TABLERO DE CORCHO TAPIZADO
 FELT BOARD - TABLEAU FOND LIÈGE AVEC TISSU

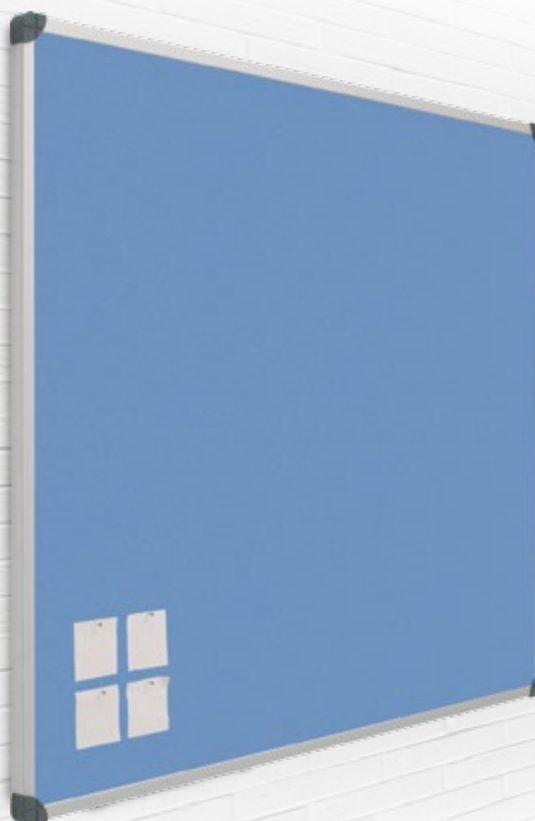
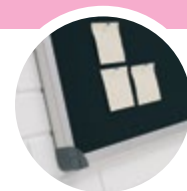

| REF | L | H | RAIL |
|--------|-----------|-----|------|
| 760/10 | 40 x 60 | 2.2 | - |
| 760/1 | 60 x 80 | 2.2 | - |
| 760/2 | 80 x 100 | 2.2 | ✓ |
| 760/3 | 100 x 120 | 2.2 | ✓ |
| 760/4 | 100 x 150 | 2.2 | ✓ |
| 760/5 | 100 x 175 | 2.2 | ✓ |
| 760/6 | 100 x 200 | 2.2 | - |
| 760/7 | 100 x 250 | 2.2 | - |

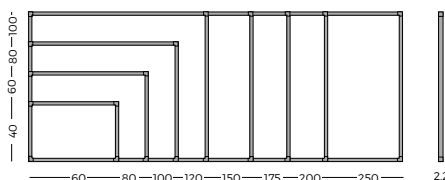

TABLERO DE CORCHO TAPIZADO

ESP. Tablero de anuncios mural con base de corcho tapizado, enmarcado con perfil de aluminio anodizado en color plata mate y cantoneras redondeadas de plástico gris. Se pueden fijar sobre su superficie notas, avisos, etc, mediante agujas. Corcho de 5 mm. de grosor.

FELT BOARD

ENG. Felt notice board equipped with silver anodized aluminium frame and grey plastic rounded corners. Ideal for pinning notes, notices, posters etc. Cork thickness: 5 mm.

TABLEAU FOND LIÈGE TISSU

FRA. Tableau d'affichage en liège tapissé avec encadrement en aluminium anodisé couleur argent, coins arrondis en plastique gris. Idéal pour l'affichage de notes, avis, posters, etc... par épingles et punaises. Liège de 5 mm de très bonne qualité.



SOPORTE T

| REF | ↑ | └┘ | ┆┆ |
|----------------|-----|-----------|----|
| 760/2/T | 190 | 100 x 80 | 53 |
| 760/3/T | 190 | 100 x 120 | 53 |
| 760/4/T | 190 | 120 x 150 | 53 |
| 760/6/T | 190 | 120 x 200 | 53 |



SOPORTE DELTA

| REF | ↑ | └┘ | ┆┆ |
|----------------|-----|-----------|----|
| 760/2/D | 190 | 100 x 80 | 53 |
| 760/3/D | 190 | 100 x 120 | 53 |
| 760/4/D | 190 | 120 x 150 | 53 |
| 760/6/D | 190 | 120 x 200 | 53 |



SOPORTE Y2

| REF | ↑ | └┘ | ┆┆ |
|-----------------|-----|-----------|----|
| + Y2/120 | 190 | 100 x 120 | 53 |
| + Y2/150 | 190 | 100 x 150 | 53 |
| + Y2/200 | 190 | 100 x 200 | 53 |

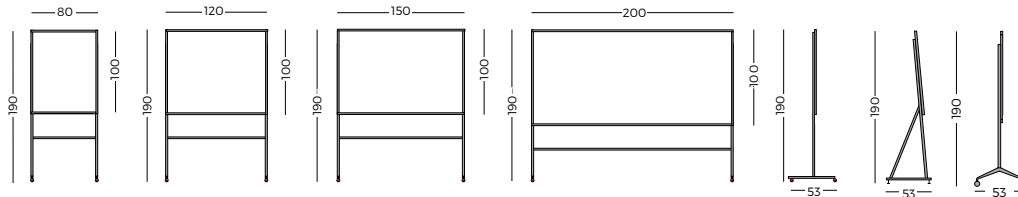

TAPIZADO



NEGRO /NG



GRIS /GR



CREMA /CR



AMARILLO /AM



NARANJA /NJ



ROJO /RJ



BURDEOS /BD



AZUL /AZ



AZUL CLARO /AC



VERDE CLARO /VC



VERDE MEDIO /VM



VERDE /VD

ZENIT

TABLERO ZENIT DE CORCHO
FELT BOARD - TABLEAU FOND LIÈGE

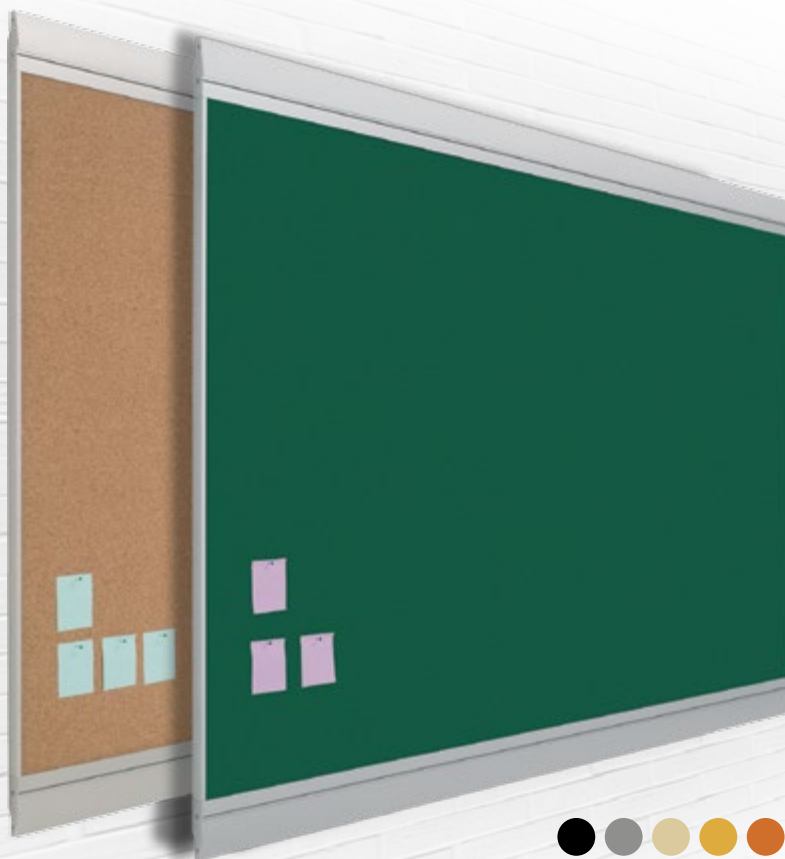

ACABADO



CORK

TAPIZADO



| REF | L | L ₁ | H | RAIL |
|----------|-----------|----------------|-----|------|
| Z/765/10 | 40 x 60 | 53 x 61 | 2,3 | - |
| Z/765/1 | 60 x 80 | 73 x 81 | 2,3 | - |
| Z/765/2 | 80 x 100 | 93 x 101 | 2,3 | ✓ |
| Z/765/3 | 100 x 120 | 113 x 121 | 2,3 | ✓ |
| Z/765/4 | 100 x 150 | 113 x 151 | 2,3 | ✓ |
| Z/765/5 | 100 x 175 | 113 x 176 | 2,3 | ✓ |
| Z/765/6 | 100 x 200 | 113 x 201 | 2,3 | - |
| Z/765/7 | 100 x 250 | 113 x 251 | 2,3 | - |

| REF | L | L ₁ | H | RAIL |
|----------|-----------|----------------|-----|------|
| Z/760/10 | 40 x 60 | 53 x 61 | 2,3 | - |
| Z/760/1 | 60 x 80 | 73 x 81 | 2,3 | - |
| Z/760/2 | 80 x 100 | 93 x 101 | 2,3 | ✓ |
| Z/760/3 | 100 x 120 | 113 x 121 | 2,3 | ✓ |
| Z/760/4 | 100 x 150 | 113 x 151 | 2,3 | ✓ |
| Z/760/5 | 100 x 175 | 113 x 176 | 2,3 | ✓ |
| Z/760/6 | 100 x 200 | 113 x 201 | 2,3 | - |
| Z/760/7 | 100 x 250 | 113 x 251 | 2,3 | - |

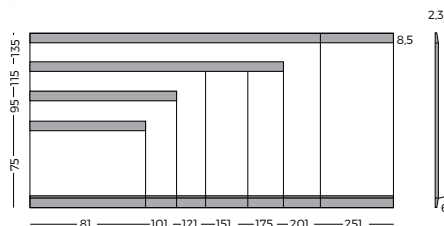

TABLERO ZENIT DE CORCHO

ESP. Tablero de corcho Zénit enmarcado con perfil de aluminio anodizado en color plata (tapa personalizable). Superficie de corcho natural o tapizada en colores. Se pueden fijar sobre su superficie notas, avisos, pósters, etc, mediante agujas o chinchetas. Corcho de 5 mm. de grosor.

ZENIT FELT BOARD

ENG. Cork or felt notice board, covered with colored fabric, with anodized aluminium frame (customizable). Cork 5 mm, high quality. Ideal for pinning notes, bulletins, posters, etc. Covered with fabric in colours black, bordeaux, blue, green, grey and ochre. Cork thickness: 5 mm.

TABLEAU ZENIT FOND LIÈGE

FRA. Tableau d'affichage avec fond liège ou liège tapissé. Encadrement en aluminium anodisé (personnalisable). Liège de 5 mm, très bonne qualité. Idéal pour l'affichage de notes, avis, posters, à l'aide d'épingles et punaises. Liège de 5 mm de très bonne qualité.



Z/760/...

Z/765/...



SOPORTE Y2

| REF | REF | ↑ | └ | └└ | └└└ |
|----------|----------|-----|-----------|-----------|-----|
| Z/765/Y2 | Z/760/Y2 | 190 | 100 x 80 | 113 x 81 | 2.3 |
| Z/765/Y3 | Z/760/Y3 | 190 | 100 x 120 | 113 x 121 | 2.3 |
| Z/765/Y4 | Z/760/Y4 | 190 | 120 x 150 | 113 x 151 | 2.3 |
| Z/765/Y6 | Z/760/Y6 | 190 | 120 x 200 | 113 x 201 | 2.3 |

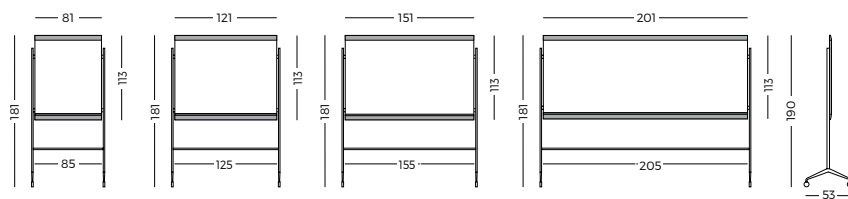

TAPIZADO



NEGRO /NG



GRIS /GR



CREMA /CR



AMARILLO /AM



NARANJA /NJ



ROJO /RJ



BURDEOS /BD



AZUL /AZ



AZUL CLARO /AC



VERDE CLARO /VC



VERDE MEDIO /VM



VERDE /VD

CHAMELEON FLOAT

TABLERO DE ANUNCIOS
INFO BOARD - TABLEAU D'INFORMATION

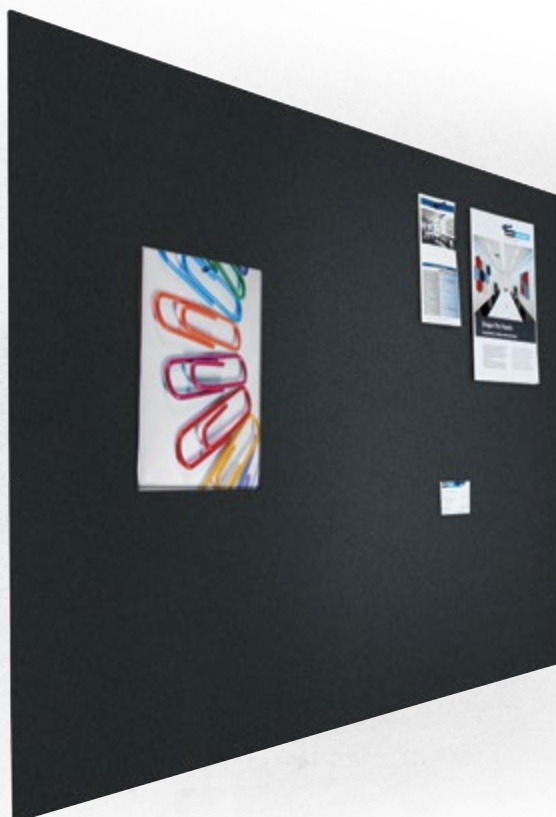

| REF | L | H |
|--------|-----------|-----|
| 7600/1 | 60 x 90 | 1,6 |
| 7600/2 | 90 x 120 | 1,6 |
| 7600/3 | 120 x 180 | 1,6 |
| 7600/4 | 120 x 200 | 1,6 |
| 7600/5 | 200 x 60 | 1,6 |

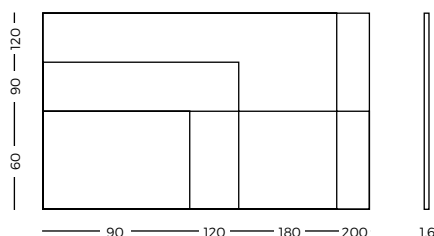

TABLERO CHAMELEON FLOAT

ESP. Tablero rectangular de alta calidad de distintas medidas fabricado con materiales naturales. La superficie es auto-reparante, acústica y con una larga vida útil. Los cantos biselados dan la sensación que se encuentra flotando en la pared una vez colgado.

CHAMELEON FLOAT PANEL

ENG. Rectangular panel with bevelled contour for attaching notes, warnings, etc using pins. Autoreparable surface, manufactured with natural materials and high sound-absorbing component.

TABLEAU CHAMELEON FLOAT

FRA. Tableau d'affichage pour accrocher notes, avis etc à l'aide de punaises. Superficie auto-réparable fabriquée avec des matériaux naturels. Composants phono-absorbents.



CHAMELEON SIX-SQUARE

TABLERO DE ANUNCIOS
INFO BOARD - TABLEAU D'INFORMATION

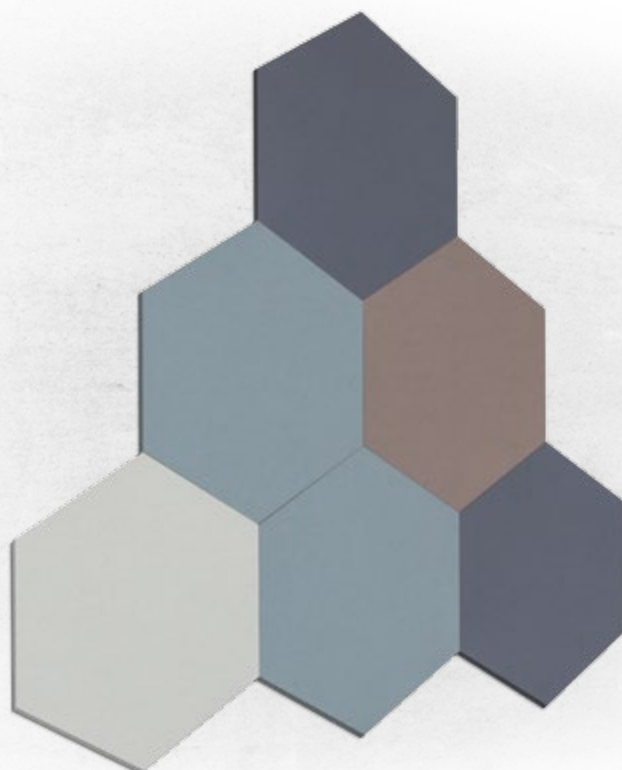

REF L H
7606/1 ø60 1,6



COLOR



/BE /MR1 /MR2 /TC /NJ /GR /GR2 /GR3 /GR4 /GR5 /AM /VD /RJ /AZ /NG

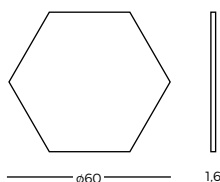

TABLERO CHAMELEON SIX-SQUARE

ESP. Tablero hexagonal de alta calidad de materiales naturales. La superficie es auto-reparante, acústica y con una larga vida útil. Mezcla, diseña y crea tu configuración perfecta gracias a los 15 colores disponibles.

CHAMELEON SIX-SQUARE PANEL

ENG. Hexagonal panel for attaching notes, warnings, etc using pins. Autoreparable surface, manufactured with natural materials and high sound-absorbing component. Mix, match and create the perfect constellation using the 15 different colours available.

TABLEAU CHAMELEON SIX_SQUARE

FRA. Tableau d'affichage hexagonale pour accrocher notes, avis etc à l'aide de punaises. Superficie auto-réparable fabriquée avec des matériaux naturelles. Composants phono-absorbents. Mélanger, concevoir et créer votre configuration parfait.



CHAMELEON ROUND

TABLERO DE ANUNCIOS
INFO BOARD - TABLEAU D'INFORMATION

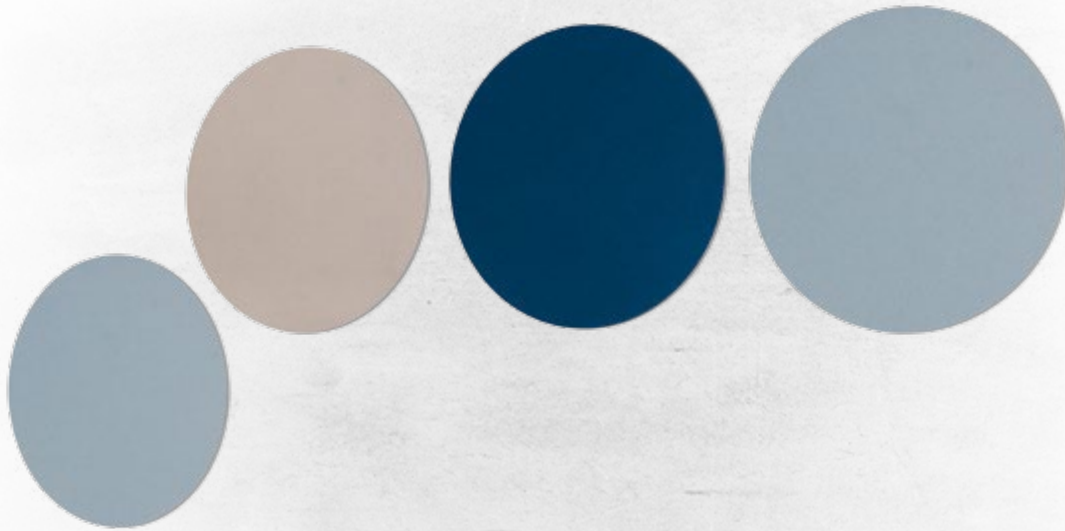

COLOR



/BE /MR1 /MR2 /TC /NJ /GR /GR2 /GR3 /GR4 /GR5 /AM /VD /RJ /AZ /NC

REF

7608/1

L ±1-
ø60 1.6

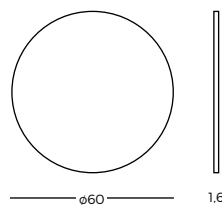

TABLERO CHAMELEON ROUND

ESP. Tablero circular de alta calidad de materiales naturales. La superficie es auto-reparante, acústica y con una larga vida útil. Mezcla, diseña y crea tu configuración perfecta gracias a los 15 colores disponibles.

CHAMELEON ROUND PANEL

ENG. Round panel for attaching notes, warnings, etc using pins. Autoreparable surface, manufactured with natural materials and high sound-absorbing component. Mix, match and create the perfect constellation using the 15 different colours available.

TABLEAU CHAMELEON ROUND

FRA. Tableau d'affichage rond pour accrocher notes, avis etc à l'aide de punaises. Superficie auto-réparable fabriquée avec des matériaux naturels. Composants phono-absorbents. Mélanger, concevoir et créer votre configuration parfait.

VITRINAS - /V

VITRINA DE PUERTAS CORREDERAS
SHOWCASE SLIDING DOORS - PORTES COULISSANTES

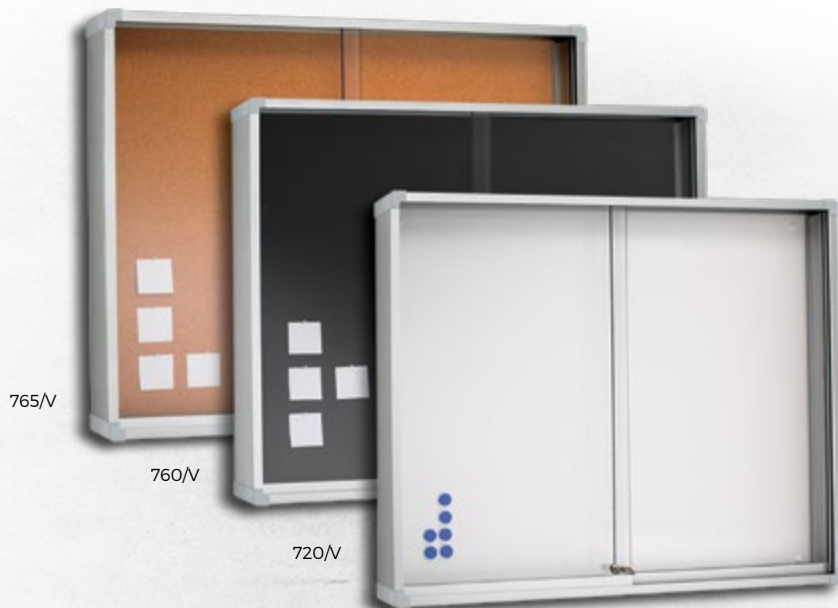

ACABADO - TAPIZADO



CORK /NG /GR /CR /OC /NJ /RJ /BD /AZ /AC /VC /VM /VD
765/V 760/V

| REF | REF | L | h | h |
|--------|--------|-----------|-----|---|
| 765/V1 | 760/V1 | 60 x 80 | 2,5 | 7 |
| 765/V2 | 760/V2 | 80 x 100 | 2,5 | 7 |
| 765/V3 | 760/V3 | 100 x 120 | 2,5 | 7 |
| 765/V4 | 760/V4 | 100 x 150 | 2,5 | 7 |
| 765/V5 | 760/V5 | 100 x 175 | 2,5 | 7 |
| 765/V6 | 760/V6 | 100 x 200 | 2,5 | 7 |



ACABADO



PIZARRA
720

| REF | L | h | h |
|--------|-----------|-----|---|
| 720/V1 | 60 x 80 | 2,5 | 7 |
| 720/V2 | 80 x 100 | 2,5 | 7 |
| 720/V3 | 100 x 120 | 2,5 | 7 |
| 720/V4 | 100 x 150 | 2,5 | 7 |
| 720/V5 | 100 x 175 | 2,5 | 7 |
| 720/V6 | 100 x 200 | 2,5 | 7 |

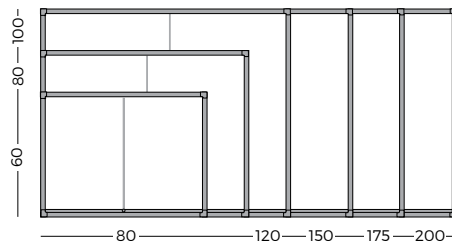

VITRINA CON PUERTAS CORREDERAS

ESP. Vitrina de anuncios mural con opciones fondo de corcho, corcho tapizado o magnético, marco de aluminio anodizado en color plata mate natural y cantoneras redondeadas de zamak gris, puertas correderas de metacrilato y cerradura con llave.

SHOWCASE WITH SLIDING DOORS

ENG. Showcase with cork, felt cork or magnetic surface equipped with silver anodized aluminium frame and grey zamak rounded corners, methacrylate locking sliding doors. Ideal for pinning notes, bulletins, posters, etc.

VITRINE AVEC PORTES COULISSANTES

FRA. Vitrine fond en liège, liège tapissé ou magnétique avec encadrement en aluminium anodisé couleur argent, coins arrondis en zamak gris et portes coulissantes en méthacrylate avec serrure. Idéal pour l'affichage de notes, avis, posters, etc., par épingles et punaises.



SOPORTE T - 765

| REF | ↑ | L | □ | ⊥ |
|----------|-----|-----------|-----|----|
| 765/V/T2 | 183 | 100 x 80 | 2,5 | 53 |
| 765/V/T3 | 183 | 100 x 120 | 2,5 | 53 |
| 765/V/T4 | 183 | 120 x 150 | 2,5 | 53 |



SOPORTE T - 760

| REF | ↑ | L | □ | ⊥ |
|----------|-----|-----------|-----|----|
| 760/V/T2 | 183 | 100 x 80 | 2,5 | 53 |
| 760/V/T3 | 183 | 100 x 120 | 2,5 | 53 |
| 760/V/T4 | 183 | 120 x 150 | 2,5 | 53 |



SOPORTE T - 720

| REF | ↑ | L | □ | ⊥ |
|----------|-----|-----------|-----|----|
| 720/V/T2 | 183 | 100 x 80 | 2,5 | 53 |
| 720/V/T3 | 183 | 100 x 120 | 2,5 | 53 |
| 720/V/T4 | 183 | 120 x 150 | 2,5 | 53 |

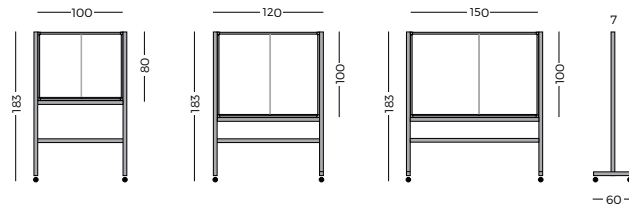

-60-

TAPIZADO



NEGRO /NG



GRIS /GR



CREMA /CR



AMARILLO /AM



NARANJA /NJ



ROJO /RJ



BURDEOS /BD



AZUL /AZ



AZUL CLARO /AC



VERDE CLARO /VC



VERDE MEDIO /VM



VERDE /VD

VITRINAS ZENIT

VITRINA ZENIT DE PUERTAS CORREDERAS
SHOWCASE SLIDING DOORS - PORTES COULISSANTES



ACABADO - TAPIZADO



| REF | REF | L | L ₁ | h | h ₁ |
|----------|----------|----------|----------------|-----|----------------|
| Z/765/V1 | Z/760/V1 | 55 x 75 | 70 x 80 | 2.5 | 7 |
| Z/765/V2 | Z/760/V2 | 75 x 95 | 90 x 98 | 2.5 | 7 |
| Z/765/V3 | Z/760/V3 | 95 x 115 | 110 x 120 | 2.5 | 7 |
| Z/765/V4 | Z/760/V4 | 95 x 145 | 110 x 150 | 2.5 | 7 |
| Z/765/V5 | Z/760/V5 | 95 x 170 | 110 x 175 | 2.5 | 7 |
| Z/765/V6 | Z/760/V6 | 95 x 195 | 110 x 200 | 2.5 | 7 |

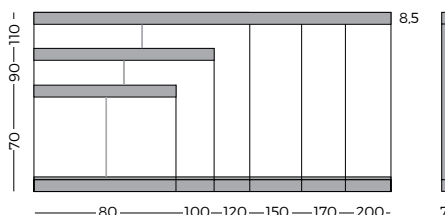

ACABADO



| REF | L | L ₁ | h | h ₁ |
|----------|----------|----------------|-----|----------------|
| Z/720/V1 | 55 x 75 | 70 x 80 | 2.5 | 7 |
| Z/720/V2 | 75 x 95 | 90 x 98 | 2.5 | 7 |
| Z/720/V3 | 95 x 115 | 110 x 120 | 2.5 | 7 |
| Z/720/V4 | 95 x 145 | 110 x 150 | 2.5 | 7 |
| Z/720/V5 | 95 x 170 | 110 x 175 | 2.5 | 7 |
| Z/720/V6 | 95 x 195 | 110 x 200 | 2.5 | 7 |



VITRINA ZENIT

ESP. Vitrina "Zenit" de anuncios mural con opciones fondo de corcho, corcho tapizado o magnético, marco de aluminio anodizado en color plata mate natural, puertas correderas de metacrilato y cerradura con llave.

ZENIT SHOWCASE

ENG. Showcase "Zenit" with cork, felt cork or magnetic surface and anodized aluminium frame. Methacrylat secured sliding doors with key. Ideal for pinning up notes, notices, posters, etc.

VITRINE ZENIT

FRA. Vitrine "Zenit" fond liège naturel, liège tapissé ou magnétique avec encadrement en aluminium anodisé. Portes coulissantes en méthacrylate avec serrure. Idéal pour l'affichage de notes, avis, posters, etc., par épingles et punaises.



SOPORTE Y2 - 765

| REF | ↑ | L | ┌ | └ |
|-----------|-----|----------|-----------|----|
| Z/765/NY2 | 181 | 75 x 95 | 90 x 100 | 53 |
| Z/765/NY3 | 181 | 95 x 115 | 110 x 120 | 53 |
| Z/765/NY4 | 181 | 95 x 145 | 110 x 150 | 53 |
| Z/765/NY5 | 181 | 95 x 170 | 110 x 175 | 53 |
| Z/765/NY6 | 181 | 95 x 195 | 110 x 200 | 53 |



SOPORTE Y2 - 760

| REF | ↑ | L | ┌ | └ |
|-----------|-----|----------|-----------|----|
| Z/760/NY2 | 181 | 75 x 95 | 90 x 100 | 53 |
| Z/760/NY3 | 181 | 95 x 115 | 110 x 120 | 53 |
| Z/760/NY4 | 181 | 95 x 145 | 110 x 150 | 53 |
| Z/760/NY5 | 181 | 95 x 170 | 110 x 175 | 53 |
| Z/760/NY6 | 181 | 95 x 195 | 110 x 200 | 53 |



SOPORTE Y2 - 720

| REF | ↑ | L | ┌ | └ |
|-----------|-----|----------|-----------|----|
| Z/720/NY2 | 181 | 75 x 95 | 90 x 100 | 53 |
| Z/720/NY3 | 181 | 95 x 115 | 110 x 120 | 53 |
| Z/720/NY4 | 181 | 95 x 145 | 110 x 150 | 53 |
| Z/720/NY5 | 181 | 95 x 170 | 110 x 175 | 53 |
| Z/720/NY6 | 181 | 95 x 195 | 110 x 200 | 53 |

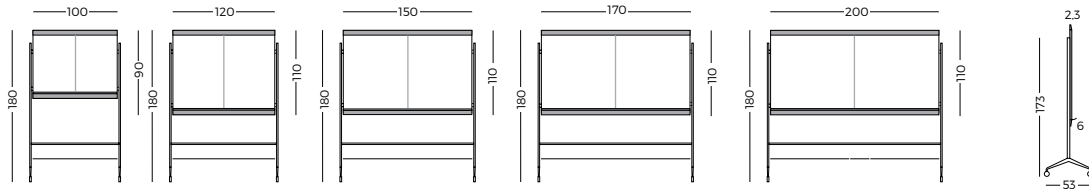

TAPIZADO



NEGRO /NG



GRIS /GR



CREMA /CR



AMARILLO /AM



NARANJA /NJ



ROJO /RJ



BURDEOS /BD



AZUL /AZ



AZUL CLARO /AC



VERDE CLARO /VC



VERDE MEDIO /VM



VERDE /VD

VITRINAS

VITRINA CON PUERTA ABATIBLE
SHOWCASE WITH SWING DOOR - VITRINE PORTE BATTANTE



ACABADO - TAPIZADO



ACABADO



| REF | REF | L | W | H | A4 |
|----------|----------|---------|-----|-----|----|
| 765/VP/1 | 760/VP/1 | 38 x 50 | 1,8 | 3,5 | 4 |
| 765/VP/2 | 760/VP/2 | 70 x 50 | 1,8 | 3,5 | 6 |
| 765/VP/3 | 760/VP/3 | 70 x 75 | 1,8 | 3,5 | 9 |

| REF | REF | L | W | H | A4 |
|------------|------------|--------------|-----|-----|----|
| BL/IN/0110 | BL/IN/0150 | 68,5 x 51,5 | 1,8 | 3,5 | 6 |
| BL/IN/0111 | BL/IN/0151 | 100,5 x 51,5 | 1,8 | 3,5 | 8 |
| BL/IN/0112 | BL/IN/0152 | 100,5 x 74,5 | 1,8 | 3,5 | 10 |

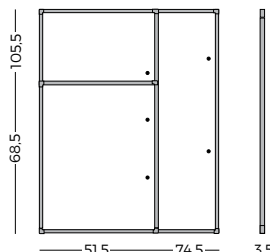
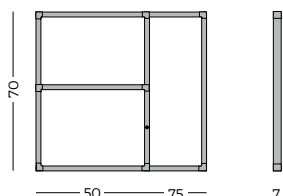

VITRINA CON PUERTA ABATIBLE

ESP. Vitrina de anuncios mural con fondo tapizado o corcho natural, marco de aluminio anodizado en color plata mate natural y cantoneras redondeadas de zamak gris, puerta abatible de metacrilato y cerradura con llave. Se pueden fijar: notas, avisos...

SHOWCASE WITH SWING DOOR

ENG. Showcase with cork surface equipped with silver anodized aluminium frame and grey zamak rounded corners and swing doors. Lockable. Ideal for pinning notes, bulletins, posters, etc.

VITRINE À PORTE BATTANTE

FRA. Vitrine à porte battante fond liège avec encadrement en aluminium anodisé couleur argent naturel et coins arrondis en zamak gris. Équipée d'une serrure porte en méthacrylate. Idéal pour l'affichage de notes, avis, posters, etc... par épingles et punaises.



VITRINA - /VT

VITRINA PUERTA TELESCÓPICA
SHOWCASE HINGED DOOR - VITRINE PORTE TÉLESCOPIQUE

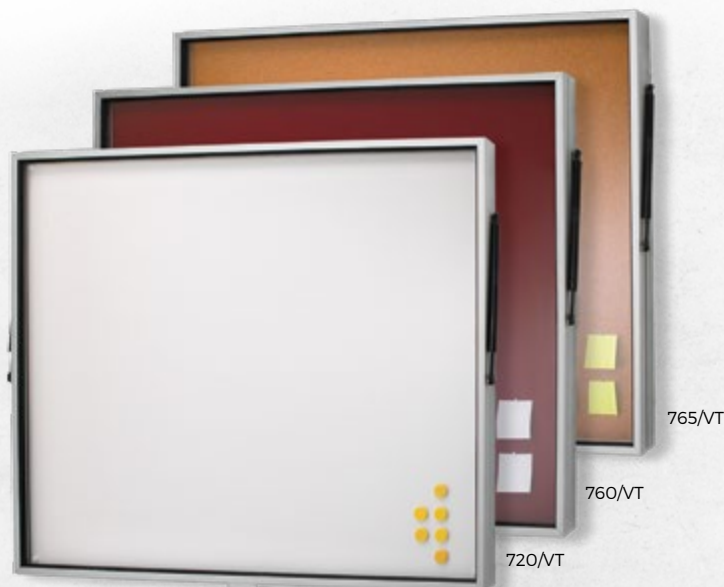

ACABADO - TAPIZADO



| REF | REF | L | H |
|---------|---------|-----------|-----|
| 765/VT1 | 760/VT1 | 60 x 80 | 4,5 |
| 765/VT2 | 760/VT2 | 80 x 100 | 4,5 |
| 765/VT3 | 760/VT3 | 100 x 120 | 4,5 |



ACABADO



| REF | L | H |
|---------|-----------|-----|
| 720/VT1 | 60 x 80 | 4,5 |
| 720/VT2 | 80 x 100 | 4,5 |
| 720/VT3 | 100 x 120 | 4,5 |

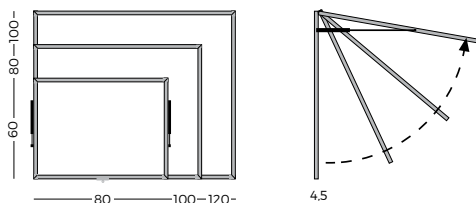

VITRINA TELESCÓPICA

ESP. Vitrina de anuncios mural con fondo de corcho natural, magnético o tapizado, marco de aluminio anodizado en color plata mate natural y puerta abatible de metacrilato mediante telescópico y cerradura con llave. Se pueden fijar sobre su superficie notas, avisos, pósters, etc.

TELESCOPIC SHOWCASE

ENG. Showcase with natural cork, felt cork or magnetic surface equipped with silver anodized aluminium frame and methacrylat hinged doors and lockable. Ideal for pinning notes, notices, posters, etc.

VITRINE PORTE TÉLESCOPIQUE

FRA. Vitrine à l'italienne fond liège, liège tissu ou magnétique avec encadrement en aluminium anodisé couleur argent naturel. Equipé d'une serrure, porte télescopique en méthacrylate. Idéal pour l'affichage de notes, avis, posters, etc... par épingles et punaises.

VITRINA - /VE

VITRINA EXTERIOR
OUTDOOR SHOWCASE - VITRINE EXTÉRIEURE



| REF | L | H | A4 |
|-----------|---------|-----|----|
| 767/VE/12 | 68 x 51 | 4,5 | 2 |
| 767/VE/13 | 68 x 72 | 4,5 | 6 |
| 767/VE/14 | 98 x 72 | 4,5 | 9 |

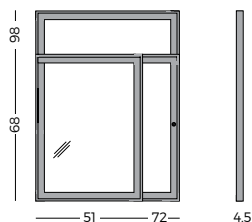

VITRINA CON PUERTA ABATIBLE

ESP. Vitrinas de anuncios murales con marco de aluminio anodizado en color plata mate de puerta abatible de cristal templado y cerradura con llave. Fondo magnético blanco. Estancas a la lluvia por lo que permiten su colocación a la intemperie.

OUTDOOR SHOWCASE

ENG. Showcase with cork surface equipped with silver anodized aluminium frame. Swinging door with tempered glass and locking mechanism. Magnetic white surface. Weather resistant and waterproof.

VITRINE EXTÉRIEURE

FRA. Vitrine d'extérieur avec fond tableau blanc magnétique et encadrement en aluminium anodisé de couleur gris mate. Porte battante en polycarbonate et serrure clé, résistante aux intempéries.



VITRINA - /VE

VITRINA EXTERIOR TELESCÓPICA
TELESCOPIC OUTDOOR SHOWCASE - VITRINE EXTÉRIEURE TÉLESCOMPIQUE

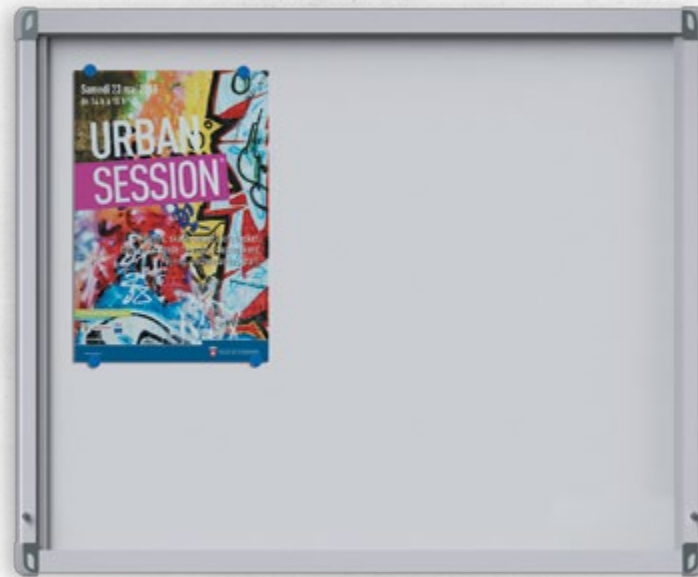

| REF | L | H | A4 |
|-----------|-----------|---|----|
| 768/VE/11 | 99 x 121 | 5 | 15 |
| 768/VE/12 | 99 x 163 | 5 | 21 |
| 768/VE/13 | 101 x 204 | 5 | 27 |



| REF | L | H | A4 |
|------------|----------|-----|----|
| 768/VEP/11 | 98 x 117 | 7,5 | 15 |
| 768/VEP/12 | 98 x 160 | 7,5 | 21 |
| 768/VEP/13 | 98 x 202 | 7,5 | 27 |

+ Soporte T
+ T support
+ Support T

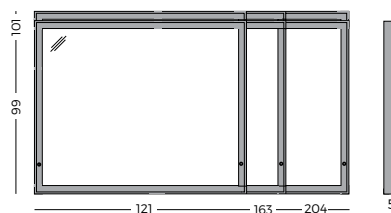

VITRINA DE EXTERIOR

ESP. Vitrinas de anuncios murales o con soportes con marco de aluminio anodizado en color plata mate de puerta telescópica de cristal templado y cerradura con llave. Fondo magnético blanco. Estancas a la lluvia por lo que permiten su colocación a la intemperie.

OUTDOOR SHOWCASE

ENG. Showcase with cork surface equipped with silver anodized aluminium frame. Hinged door with tempered glass and locking mechanism. Magnetic white surface. Weather resistant and waterproof.

VITRINE EXTÉRIEURE

FRA. Vitrine d'extérieur avec fond tableau blanc magnétique et encadrement en aluminium anodisé argent naturel. Portes à l'italienne en polycarbonate avec serrure clé, résistante aux intempéries.

EXPOPLAN

SISTEMAS DE EXPOSICIÓN
DISPLAY SYSTEMS
SYSTÈMES D'EXPOSITION



NEXT BASIC

POSTES BASIC DE CORDÓN
 QUEUE ROPE GUIDES - POTEAUX GUIDES CORDES



POSTE DE ALUMINIO



/NG /PL /DO

| REF | ↑ | — | ∅ |
|--------|-----|----|---|
| 805/NG | 100 | 36 | 5 |
| 805/PL | 100 | 36 | 5 |
| 805/DO | 100 | 36 | 5 |

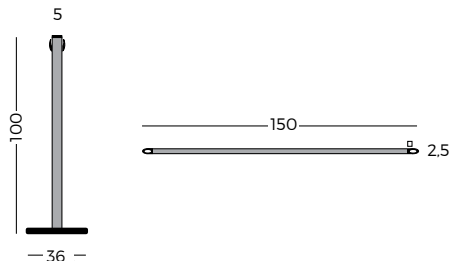

CORDÓN



/NG /AZ /RJ /BD /CR */BL */NG

| REF | ∅ | — |
|-----------|-----|-----|
| 805/C/NG | 2.5 | 150 |
| 805/C/AZ | 2.5 | 150 |
| 805/C/RJ | 2.5 | 150 |
| 805/C/BD | 2.5 | 150 |
| 805/C/CR | 2.5 | 150 |
| 806/C/BL* | 2.5 | 150 |
| 806/C/NG* | 2.5 | 150 |

POSTES "BASIC" DE CORDÓN

ESP. Poste separador de aluminio con base metálica negra, resistente y de gran estabilidad, para separaciones de áreas y guiado peatonal. Disponible en 3 colores: negro, plata y oro. Cordón de 1,5 m, disponible en 2 trenzados distintos.

QUEUE GUIDES "BASIC"

ENG. Aluminium queue guide with very stable black metallic base for separating different areas and forming organized queues. Available in 3 colours: black, silver and gold. 1.5 meter rope available in different styles (thick or thin braid).

POTEAUX GUIDES "BASIC"

FRA. Poteau stable en aluminium, socle métallique noir, très résistant. S'intègre à tous les espaces d'accueil, délimitation des zones et flux piétonnier. Disponibles en 3 couleurs: noir, argent et or. Cordes de 1,5 m, disponibles en deux types de tresses.



NEXT LUXE

POSTES LUXE DE CORDÓN
QUEUE ROPE GUIDES - POTEAUX GUIDES CORDES



POSTE DE ALUMINIO



/NG /PL /DO /GR /CR

| REF | — | — | ∅ |
|--------|----|----|---|
| 804/CR | 95 | 35 | 5 |
| 804/DO | 95 | 35 | 5 |
| 804/GR | 95 | 35 | 5 |
| 804/PL | 95 | 35 | 5 |
| 804/NG | 95 | 35 | 5 |

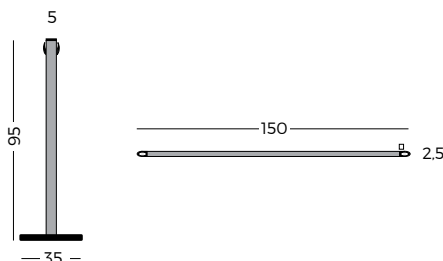

CORDÓN



/NG /AZ /RJ /BD /CR /BL /NG

| REF | ∅ | — |
|-----------|-----|-----|
| 804/C/NG | 2.5 | 150 |
| 804/C/AZ | 2.5 | 150 |
| 804/C/RJ | 2.5 | 150 |
| 804/C/BD | 2.5 | 150 |
| 804/C/CR | 2.5 | 150 |
| 804/CT/BL | 2.5 | 150 |
| 804/CT/NG | 2.5 | 150 |

POSTES "LUXE" DE CORDÓN

ESP. Poste separador de tubo y base de latón, resistente y de gran estabilidad, para separaciones de áreas y guiado peatonal. Disponible en 5 colores. Cordón de 1,5 m, disponible en 2 trenzados distintos.

QUEUE GUIDES "LUXE"

ENG. Queue guide with a very stable brass base for separating different areas and forming organized queues. Available in 5 colours. 1,5 meter rope available in different styles (thick or thin braid).

POTEAUX GUIDES "LUXE"

FRA. Poteau avec socle en laiton, très stable et résistant. S'intègre à tous les espaces d'accueil, délimitation des zones et flux des piétons. Disponibles en 5 couleurs. Cordes de 1,5 m, disponibles en deux types de tresses différentes.

NEXT TRAC

POSTES DE CINTA RETRÁCTIL
RETRACTABLE QUEUE GUIDES - POTEAU À SANGLE RÉTRACTABLE



POSTE METÁLICO



POSTE LACADO



CORDÓN



| REF | ↑ | → | ∅ |
|---------|----|----|---|
| 808/... | 95 | 35 | 7 |



| REF | DESCR. | ↑ | → | ∅ |
|----------|-------------|----|----|---|
| 808/F/LC | Poste Final | 95 | 35 | 7 |
| 808/F/M | Poste Final | 95 | 35 | 7 |
| 800/TP | Mural | 7 | 1 | - |

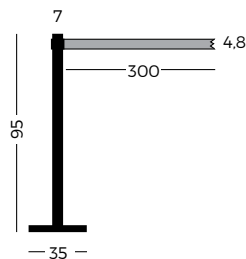

POSTES DE CINTA RETRÁCTIL

ESP. Poste separador metálico de 95 y 50 cm de alto, para separaciones de áreas y guiado peatonal. Disponibles en varios colores tanto de poste como de cinta, disponible en 3 m. de largo. El cabezal del poste incorpora 3 vías de enganche.

RETRACTABLE QUEUE GUIDES

ENG. 50 or 95 cm height barrier-post for areas delimitation and users guidance. Posts and tapes available in different colors. 3 m. tapes. 1 tape starting slot and 3 ending slots for multiple layouts.

GUIDE-FILES À SANGLE RÉTRACTABLE

FRA. Poteau guide-file de 50 ou 95 cm. de haut pour délimitation d'espaces et guidage des usagers. Poteaux et sangles disponibles dans différentes couleurs. Sangles de 3 m. Un départ de sangle et 3 arrivées permettant de nombreuses configurations.



SOPORTE DIN A4

REF L ?
800/PP 30 x 21 A4

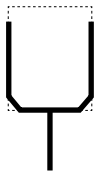

PERSONALIZADO

ESP. Consigue una cinta retráctil personalizada con el logotipo de tu empresa o marca. Contáctate con nuestra Oficina Técnica para más detalles.

ENG. Customize your queue guides with a company or brand logo. For more information, contact our Technical Departments.

FRA. Obtenir votre sangle retractable personnalisée avec le logo ou la marque de votre entreprise. Contactez nous pour plus de détail.

GAMA DE COLORES



| REF. | /BL | /NG | /GR | /AZO | /AZ | /BD | /RJ | /NJ | /AM | /FL | /VD |
|------|---------|-------|------|-------------|------|----------|-------|---------|----------|--------------|-------|
| | Blanco | Negro | Gris | Azul oscuro | Azul | Burdeos | Rojo | Naranja | Amarillo | Fluorescente | Verde |
| | White | Black | Grey | Dark Blue | Blue | Cardinal | Red | Orange | Yellow | Fluorescent | Green |
| | Blanche | Noir | Gris | Bleu foncé | Bleu | Bordeaux | Rouge | Orange | Jaune | Fluorescent | Vert |

NEXT ECO

POSTE ECO DE CINTA RETRÁCTIL
BARRIER-POST "ECO" RETRACTABLE - POTEAU À SANGLE RÉTRACTABLE



| REF | ↑ | ← | ∅ |
|-----------|----|----|---|
| 803/E2/NG | 95 | 35 | 5 |
| 803/E2/RJ | 95 | 35 | 5 |



COLOR

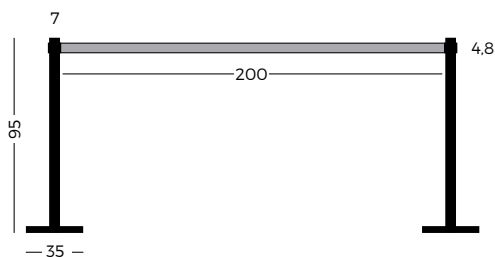

POSTES METÁLICOS "ECO"

ESP. Caja de 2 postes separadores metálicos de 95 cm de alto, para separaciones de áreas y guiado peatonal. Poste de color negro y cinta retráctil de 2 m. disponible en rojo y negro.

BARRIER-POSTS "ECO"

ENG. Barrier-post eco 95 cm for areas delimitation and users guidance. Black posts, tape available in red or black. One starting slot and 3 ending slots for multiple layouts.

POTEAUX GUIDE-FILE "ÉCO"

FRA. Poteau guide-file éco 95 cm. de haut pour délimitation d'espaces et guidage des usagers. Poteaux noirs, sangle rouge ou noire. Un départ de sangle et 3 arrivées permettant différentes configurations.



NEXT WALL

CINTA EXTENSIBLE RETRÁCTIL MURAL
WEBBING FELT FOR WALL - SANGLE RETRACTABLE MURALE

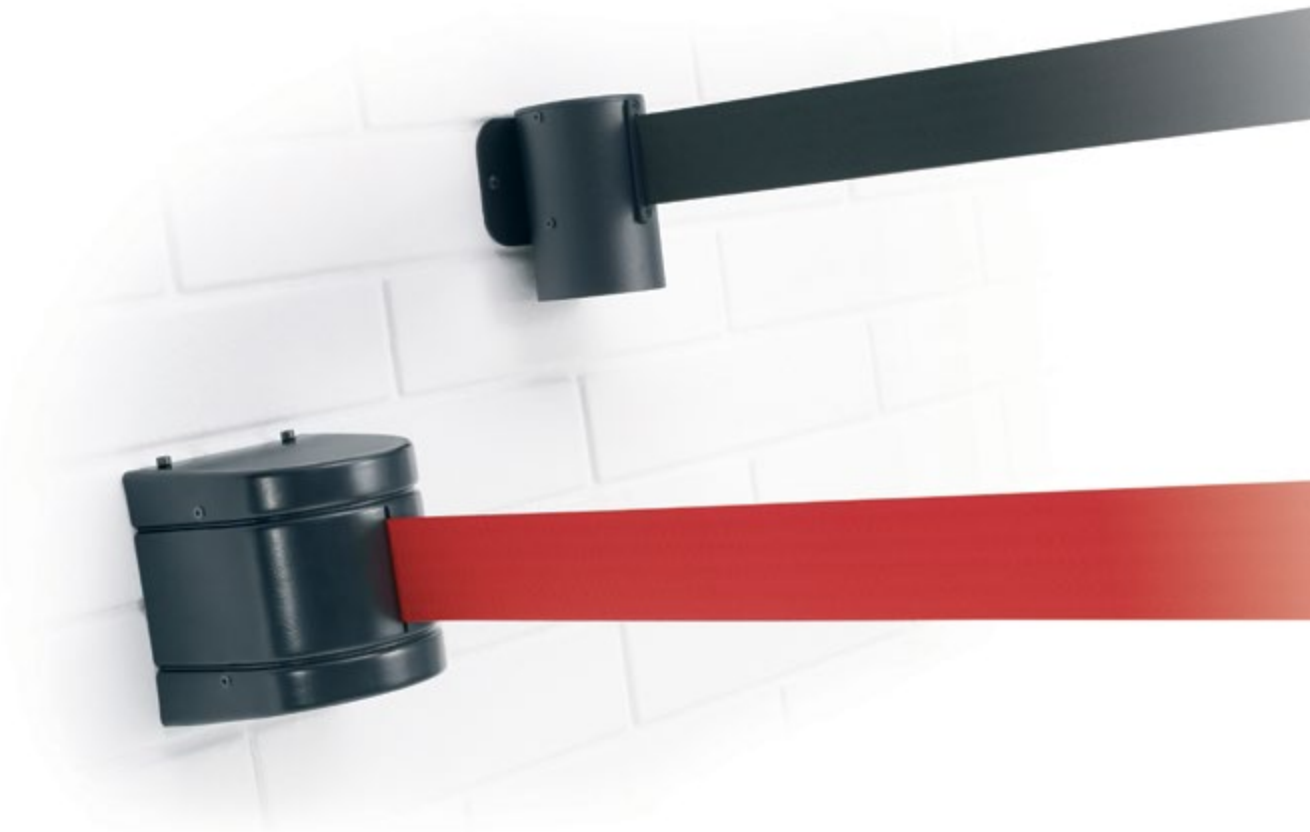

| REF | ↑ | → |
|--------|-----|-----|
| 800/23 | 4,8 | 250 |
| 800/37 | 4,8 | 370 |
| 800/52 | 4,8 | 520 |
| 800/77 | 4,8 | 770 |

| REF | DESCR. | ↑ | → | ∅ |
|--------|--------|---|---|---|
| 800/TP | Mural | 7 | 1 | - |

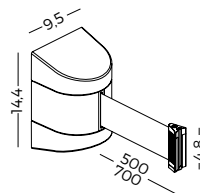
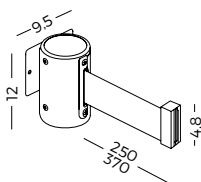

CINTA EXTENSIBLE RETRACTIL MURAL

ESP. Elemento mural de cinta extensible retráctil, permite de manera rápida y segura aislar provisionalmente áreas o zonas de paso, y cerrar puertas o zonas determinadas. Disponible en 4 longitudes; 2,5 m., 3,7 m., 5,2 m. y 7,7 m.

WEBBING FELT FOR WALL

ENG. Wall adjustable barrier belt for quick and easy use to close off areas temporarily. Available in 4 lengths; 2,5 m., 3,7 m., 5,2 m. y 7,7 metres.

SANGLE RETRACTABLE MURALE

FRA. Sangle murale rétractable avec système d'autofreinage afin qu'elle ne se rétracte pas brusquement en cas de décrochage. Délimitation efficace et rapide de tout type de surfaces. Disponible en quatre longueurs: 2,5 m., 3,7 m., 5,2 m. et 7,7 mètres.

821-823

ATRIL DE MARCO ABATIBLE
SNAPFRAME LECTERN - PUPITRE À CADRE CLIPPANT



| REF | ↑ | → | ☐ |
|---------------|-----|---------|----|
| 821/A3 | 110 | 30 x 40 | A3 |
| 821/A4 | 110 | 30 x 40 | A4 |

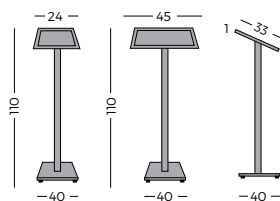

| REF | ↑ | → | ☐ | CA |
|------------------|-------|---------|----|----|
| 823/PF/CA | 127,6 | 25 x 33 | A4 | Si |

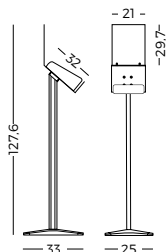

| REF | ↑ | → | ☐ | CA |
|---------------|-------|---------|----|----|
| 823/PF | 116,3 | 25 x 33 | A4 | No |

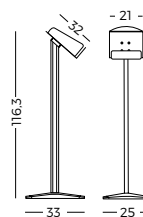

ATRIL DE MARCO ABATIBLE

ESP. Atril expositor de aluminio de marco abatible para exponer toda clase de información, catálogos, menús... El portapóster superior A4 y A3 permite adaptarse al soporte en posición vertical u horizontal.

SNAPFRAME LECTERN

ENG. Snapframe aluminium display, ideal to show all sorts of information, catalogues, menus, etc... The upper snapframe A4 and A3 allows to place it vertical or horizontal.

PUPITRE À CADRE CLIPPANT

FRA. Pupitre en aluminium à cadre clippant pour exposer tout type d'informations, catalogues, menus, etc... Le porte affiche A4 ou A3 peut se positionner horizontalement ou verticalement.



822

ATRIL DE MARCO ABATIBLE Y REGULABLE
ADJUSTABLE LECTERN WITH SNAPFRAME - MENUBOARD FLEXIBLE



| REF | W | H | Inclination | Format |
|---------------|---------|---------|-------------|--------|
| 822/A3 | 42 x 30 | 0 - 90° | A3 | |
| 822/A4 | 33 x 24 | 0 - 90° | A4 | |

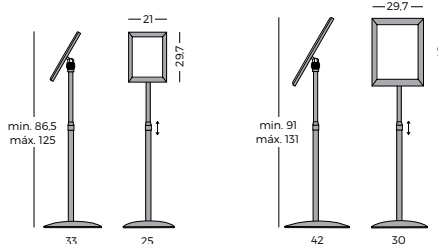
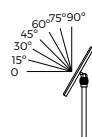

| REF | W | H | Inclination | Format | Power |
|-----------------|---------|---------|-------------|-------------|-------|
| 822/A3/L | 42 x 30 | 0 - 90° | A3 | 2000-2200 W | |
| 822/A4/L | 33 x 24 | 0 - 90° | A4 | 2000-2200 W | |



ATRIL MARCO ABATIBLE Y REGULABLE

ESP. Atril expositor graduable en altura de aluminio de marco abatible para exponer toda clase de información, catálogos, menús. El portapóster superior Din A4 y Din A3 permite adaptarse al soporte en posición vertical y horizontal y es graduable en inclinación de 0° a 90°. (Disponible con caja de luz LED)

ADJUSTABLE LECTERN SNAP FRAME

ENG. Height adjustable lectern made of aluminium and with snap frame to hold menus, catalogues, general information...The snap frame is available in A4 and A3 format and can be positioned horizontal or vertically and with a inclination from 0° to 90°. (Led showcase light available)

MENUBOARD FLEXIBLE

FRA. Pupitre exposant réglable en hauteur et en aluminium avec cadre auto clippant pour exposer toutes sortes d'informations, catalogues, menus. La partie supérieure pour documents format A4 et A3 et avec l'inclinaison verticale et horizontale réglable de 0° à 90°. (Disponible Pupitre exposant avec LED)

832-2400

EXPOSITORES DE INFORMACIÓN
INFO DISPLAYS - PORTE-AFFICHES



REF | — — □
832/4 186 72 x 40 4



REF | — — □
2400/1B 186 72 x 40 1

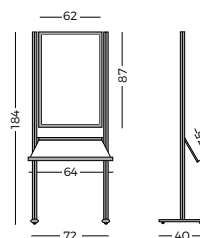
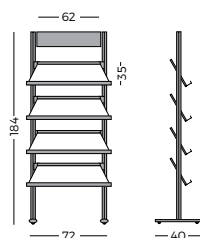

EXPOSITORES DE INFORMACIÓN

ESP. Expositores compuestos por 2 perfiles elípticos verticales de aluminio en plata mate, con estantes metálicos pintados en color gris. Ideal para catálogos y revistas en formato DIN A4.

INFO DISPLAYS

ENG. Displays made of 2 vertical elliptical aluminum supports in matt silver. Metallic shelves painted in grey. Ideal for catalogues and magazines in A4 format. At the top there is a grey panel, which can be personalized.

PORTE-AFFICHES

FRA. Présentoirs composés de 2 supports élliptiques verticaux en aluminium couleur argent mat avec des étagères métalliques grises. Idéal pour catalogues et revues format A4.



QUADRA

EXPOSITORES DE INFORMACIÓN
MAGAZINES DISPLAYS - PRÉSENTOIRS



| REF | ↑ | → | □ |
|-------------------|-----|----------|---|
| Q/400/PE | 195 | 100 x 40 | 1 |
| Q/400/PE/D | 195 | 100 x 40 | 2 |

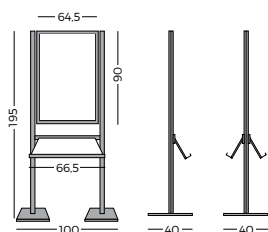

| REF | ↑ | → | □ |
|------------------|-----|----------|---|
| Q/400/3 | 195 | 100 x 40 | 3 |
| Q/400/3/D | 195 | 100 x 40 | 6 |

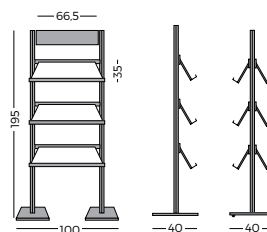

EXPOSITORES DE INFORMACIÓN

ESP. Conjunto formado por un portapósters de formato DIN A1, a una o dos caras y portaestantes metálico gris sobre estructura doble de aluminio anodizado en plata mate, serie Quadra.

MAGAZINES DISPLAYS "QUADRA"

ENG. Displays made of 2 vertical elliptical aluminum supports in matt silver. Metallic shelves painted in grey. Ideal for catalogues and magazines in A4 format. The shelves can be placed on one or both sides.

PRÉSENTOIRS "QUADRA"

FRA. Présentoirs composés de 2 supports "Quadra" verticaux en aluminium couleur argent mat avec des étagères métalliques grises. Idéal pour catalogues et revues format A4. Les étagères peuvent se situer sur un ou deux côtés.

Q-T

POSTE DE INFORMACIÓN
INFO SYSTEM - BARRE D'INFORMATION



| REF | ↑ | — |
|-------|-----|---------|
| Q/198 | 95 | 30 x 40 |
| Q/199 | 150 | 30 x 40 |
| Q/200 | 195 | 30 x 40 |
| Q/201 | 225 | 30 x 40 |

No incluye accesorios.
Does not include accessories.
Accessoires non inclus.

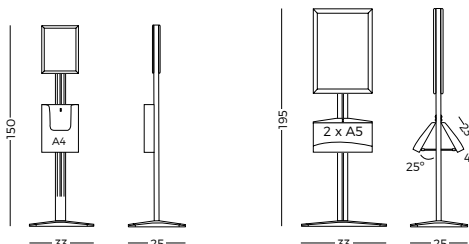

| REF | ↑ | — |
|-------|-----|---------|
| T/198 | 95 | 30 x 40 |
| T/199 | 150 | 30 x 40 |
| T/200 | 195 | 30 x 40 |
| T/201 | 225 | 30 x 40 |

No incluye accesorios.
Does not include accessories.
Accessoires non inclus.



POSTE DE INFORMACIÓN "QUADRA"

ESP. Sistema de exposición compuesto de un perfil de aluminio anodizado plata mate vertical, con base metálica cuadrada pintada en color gris. El perfil tiene dos ranuras sobre las que podemos aplicar diferentes accesorios, pinzas, portafolletos, etc.

INFO SYSTEM "QUADRA"

ENG. Display system composed of a vertical matt silver aluminum anodized profile with a metallic square base painted in grey. The profile has 2 slots to be fitted with accessories like grips, document holders, etc. Ideal for congresses, exhibitions, sale points, etc..

BARRE D'INFORMATION "QUADRA"

FRA. Système d'exposition composé d'une barre verticale en aluminium anodisé de couleur argent avec un socle carré en métal de couleur gris. La barre est rainurée sur ses 2 cotés opposés pour y fixer différents accessoires, pinces, portes brochures ou dépliants.



MARCO

| REF | ┌ | ┐ | └┘ |
|-----------------|-----------|----------|-----|
| 850/I/M0 | 82 x 117 | A0 | 1,2 |
| 850/I/M1 | 57 x 82 | A1 | 1,2 |
| 850/I/M2 | 40 x 58 | A2 | 1,2 |
| 850/I/M3 | 68 x 98 | 70 x 100 | 1,2 |
| 850/I/M4 | 48 x 68 | 50 x 70 | 1,2 |
| 850/I/M5 | 42 x 29,7 | A3 | 1,2 |
| 850/I/M6 | 21 x 29,7 | A4 | 1,2 |



DISPLAY

| REF | ┌ | ┐ | └┘ |
|---------------|-----------|--------|-----|
| A4/M | 24,5 x 22 | A4 | 3,5 |
| A5/M | 16,5 x 16 | A5 | 3,5 |
| A4/3/M | 16,5 x 11 | 1/3 A4 | 3,5 |



BANDEJA

| REF | ┌ | ┐ |
|---------------|---------|----|
| Q/2205 | 22 x 35 | A4 |

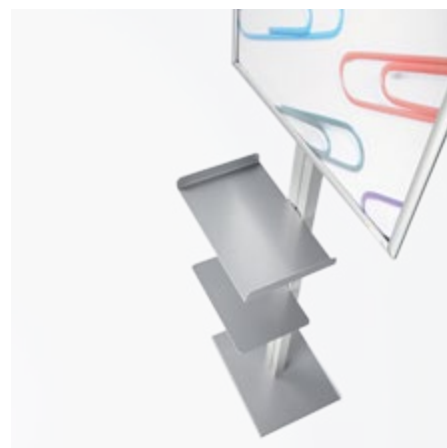

850

PORTAPÓSTERS CON MARCO ABATIBLE
WALL SNAPFRAME - CADRE MURAL CLIPPANT



| REF | ┌ | ┐ | ┆ |
|-----------------|----------|----------|-----|
| 850/I/M0 | 87 x 122 | A0 | 1,2 |
| 850/I/M1 | 62 x 87 | A1 | 1,2 |
| 850/I/M2 | 43 x 62 | A2 | 1,2 |
| 850/I/M3 | 73 x 103 | 70 x 100 | 1,2 |
| 850/I/M4 | 53 x 73 | 50 x 70 | 1,2 |
| 850/I/M5 | 33 x 43 | A3 | 1,2 |
| 850/I/M6 | 24 x 33 | A4 | 1,2 |



COLOR



* /NG /BL /AM /RJ /AZ /VD /NJ

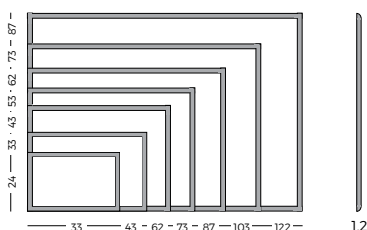

PORTAPÓSTERS MURAL

ESP. Sistema de presentación de pósters, con marco abatible de aluminio anodizado en plata mate a inglete, que permite la sustitución del impreso de una manera rápida y cómoda.

WALL SNAPFRAME

ENG. Modern and practical snapframe with durable aluminium clip frames and mitred corners. Folding for posters presentation. Poster or sheets are protected by a thin laminated plastic AV proof non reflects.

CADRE MURAL CLIPPANT

FRA. Porte-affiche en aluminium anodisé couleur argent angles droits. Ces cadres garantissent une excellente tenue des documents. L'affiche des documents sont protégées par une feuille en plastique transparente anti reflets - anti UV.



DELTA

| REF | ┌ | ? | ↑ |
|-----------------|----------|----------|-----|
| 850/I/D1 | 62 x 87 | A1 | 127 |
| 850/I/D3 | 73 x 103 | 70 x 100 | 107 |
| 850/I/D4 | 53 x 73 | 50 x 70 | 93 |



SUSPENDIDO

| REF | ┌ | ? | ↑ |
|-----------------|----------|----------|-----|
| 850/I/S0 | 87 x 122 | A0 | 2.4 |
| 850/I/S1 | 62 x 87 | A1 | 2.4 |
| 850/I/S2 | 43 x 62 | A2 | 2.4 |
| 850/I/S3 | 73 x 103 | 70 x 100 | 2.4 |
| 850/I/S4 | 53 x 73 | 50 x 70 | 2.4 |

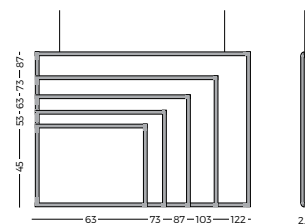
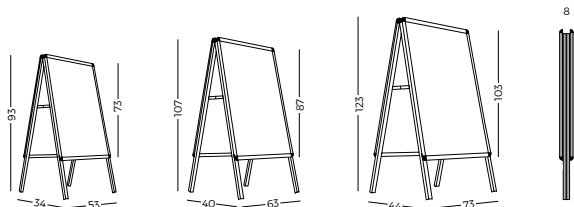

PERSONALIZACIÓN

ESP. Personalización bajo pedido. Valoración según cantidad.



ENG. Customization under order. Ask for quantities.

FRA. Personnalisation sous commande. Demander quantité

EXPOSITOR



EXPOSITORES PARA CATÁLOGOS O TARJETAS
 INFORMATION OR CARD RACKS - PRÉSENTOIRS

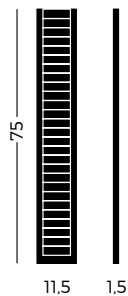
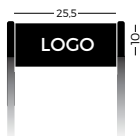
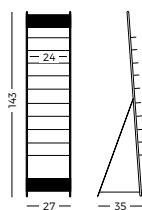

REF   

835/C/10 143 27 x 35 10 x A4



REF   

319 75 11,5 25

EXPOSITORES PARA CATÁLOGOS

ESP. Expositor para catálogos y/o revistas verticales construidos con varilla negra y cromada o para tarjetas. Su estructura es desmontable y está disponible para catálogos formato A4 o 25 tarjetas.

INFORMATION RACKS

ENG. Information racks for catalogues and/or magazines or for cards, manufactured with black chrome stems. Dismantle the structure easily for temporary use. Available for catalogues in A4 format (10 trays) or 25 cards.

PRÉSENTOIRS

FRA. Présentoir à catalogues et/ou revues verticales et cards, fabriqués en métal noir et chromée. Structure démontable pour formats A4 ou 25 cards.



837

EXPOSITOR INCLINADO
INCLINED DISPLAY - PRÉSENTOIR INCLINÉ



| REF | — | — | □ ? |
|---------------|-----|----|--------|
| 837/24 | 150 | 24 | 4 x A4 |
| 837/45 | 150 | 45 | 8 x A4 |



| REF | — | — | □ ? |
|----------------|---------|---|--------|
| VS/A4 | 30 x 21 | 3 | A4 |
| VS/A5 | 21 x 15 | 3 | A5 |
| VS/A4/3 | 15 x 10 | 3 | 1/3 A4 |

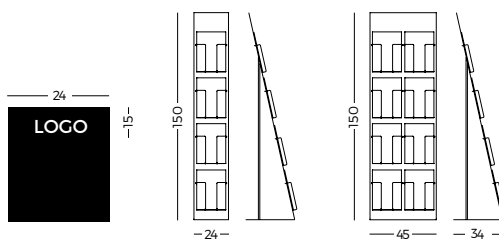

EXPOSITOR DE CHAPA

ESP. Expositor de chapa con cajetines de varilla metálica formando la composición deseada en cada momento. Las cajetines están disponibles en Din A4, A5 y formato tríptico. La parte superior puede ser rotulada o vinilada bajo pedido.

INCLINED DISPLAY IN METAL

ENG. Inclined display "Alians" made of perforated metallic structure and surface with metallic wire trays. Trays sizes can be A4, A5 or 1/3 of A4. Upper side can be personalized (logo or text).

PRÉSENTOIR INCLINÉ EN MÉTAL

FRA. Présentoir incliné "Alians" en métal. Présentoir incliné en métal perforé avec porte-brochures en tiges métalliques. Composition modulable sur formats A4 et A5 et tryptique. La partie supérieure peut être personnalisée (logo ou texte).

NOTE

PERFIL PORTANOTAS
NOTES HOLDER PROFILE - PROFIL DE SUPPORT DE NOTES



| REF | PÓSTER | (X) | - - |
|-------------------|--------|-------|------|
| BL/EX/0040 | 31 | 33,5 | 5 |
| BL/EX/0041 | 50 | 52,5 | 5 |
| BL/EX/0042 | 58 | 60,5 | 5 |
| BL/EX/0043 | 88 | 90,5 | 5 |
| BL/EX/0044 | 100 | 102,5 | 5 |
| BL/EX/0045 | 118 | 120,5 | 5 |
| BL/EX/0046 | 150 | 152,5 | 5 |

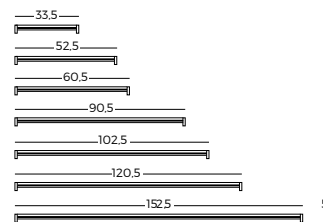
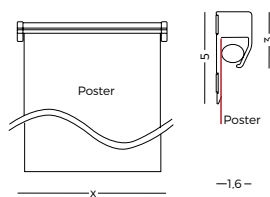

PERFIL PORTANOTAS

ESP. Perfil de aluminio anodizado en color plata mate que se fija a la pared mediante tornillos ocultos en la tapa lateral, para fijar notas, pósters, dibujos, planos, etc.

NOTES HOLDER PROFILE

ENG. Silver anodized aluminium profile fixed to the wall through hidden screws on the lateral cover. Ideal for hanging up notes, posters, drawings, plans, etc...

PROFIL DE SUPPORT DE NOTES

FRA. Profil en aluminium anodisé mat, fixé au mur par des vis ou par une bande magnétique (au choix). Idéal pour fixer des notes, posters, dessins, plans, etc...



840

EXPOSITOR INCLINADO
WALL AND FLOOR ANNOUNCEMENT BOARDS - PORTE BROCHURES



TAPIZADO



| REF | L | W | D | Trays |
|-------|----------|---|-------------|-------|
| 840/G | 115 x 80 | 3 | 9 x A4 | |
| 840/P | 90 x 58 | 3 | 12 x 1/3 A4 | |

| REF | REF | REF | L | W | D | Trays |
|--------|--------|--------|-----|----------|---|-------------|
| 840/TG | 840/DG | 840/QG | 190 | 115 x 80 | 3 | 9 x A4 |
| 840/TP | 840/DP | 840/QP | 190 | 90 x 58 | 3 | 12 x 1/3 A4 |

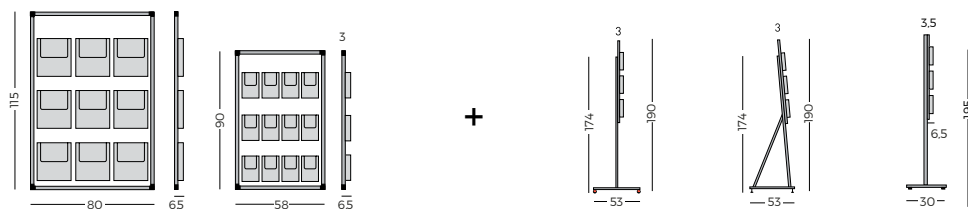

PORTAFOLLETOS MURALES Y CON PIÉ

ESP. Portafolletos de metacrilato DIN A4 y 1/3 DIN A4 montados sobre tableros tapizados en téxtil y enmarcados con perfil de aluminio. Bajo presupuesto pueden fabricarse combinaciones con formatos de cajetines (Din A4, A5 y tríptico).

WALL AND FLOOR BOARDS

ENG. Methacrylate trays DIN A4 and 1/3 A4 mounted on aluminium anodized silver frame felt announcement boards. Special order boards with different trays in different formats (A4 and A5 and brochures) can be manufactured.

PORTE BROCHURES

FRA. Porte brochures en méthacrylate format A4 et 1/3 A4 montés sur des panneaux tapissés. Sur commande on peut fabriquer des combinaisons différents formats de cases (A4, A5 et triptyques).

2000 - TEN

SISTEMA DE CABLES Y TENSORES
 CABLE AND TENSION SYSTEM - SYSTÈME DE CABLE ET POCHETTE



CARPETAS

REF ?

| | | |
|----------------|----|-------|
| ST/A4/V | A4 | VERT. |
| ST/A4/H | A4 | HOR. |
| ST/A3/V | A3 | VERT. |
| ST/A3/H | A3 | HOR. |

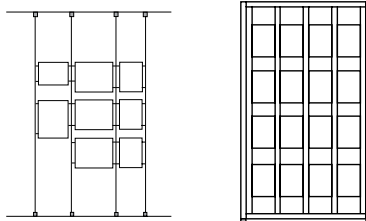

SISTEMA DE CABLES Y TENSORES

ESP. Sistema de información de cables y tensores multifuncional. Mediante cables, carpetas de metacrilato y pinzas se puede componer el diseño deseado. Disponible en varios formatos y acabados.

SISTEMA DE CABLES Y TENSORES

ENG. Multifunctional cable and tension displaying system. You can create your own design by disposing cables, methacrylate folders and pincers from the ceiling to the floor, or ceiling-suspended. Available in different formats and finishes.

SYSTÈME DE CABLE ET POCHETTE

FRA. Information, publicité ou décoration sur câble acier, pinces, tablettes et pochettes en méthacrylate. Composez votre vitrine a votre image.



CABLES Y TENSORES

| REF | ↓ | |
|-----------------|-----|--|
| 2003/TS | 300 | |
| 2003/TSC | 300 | |

PINZAS DE SUJECCIÓN

| REF | ↓ | |
|---------------|-----|--|
| 2000/2 | 0,4 | |
| 2000/3 | 0,4 | |

RAIL DE DESPLAZAMIENTO

| REF | └┘ |
|---------------|-----------|
| 2001/C | 2,5 x 100 |
| 2002/C | 2,5 x 200 |
| 2003/C | 2,5 x 300 |

ESP. Conjunto formado por 1 pieza fija a techo, pared o rail en la parte superior, cable de acero de 3 m y pieza tensora inferior.

ENG. Cables can be fitted to suit all requirements—for wall to wall, floor to ceiling, 3m length. Cables secured to an end stop.

FRA. Kit composé de 1 support fixation au plafond, mur ou rail, 1 câble en acier 3 m., et un tendeur inférieur.

ESP. Pinzas mediante las cuales se sujetan las carpetas o estantes al cable tensor. Disponibles en múltiples formatos.

ENG. Single sided or double sided support grips to hold panels, shelves or boxes. Either fixed or rotating.

FRA. Pinces de fixation permettant la liaison du câble avec les pochettes porte-visuel, tablettes ou boîtes.

ESP. Perfil de aluminio anodizado. Se atornilla a techo, suelo o pared, y en su carril se fija el tensor. Permite desplazarse a der. e izq.

ENG. Anodized aluminium finish. Screw fixing into ceiling and/or floor and/or wall. The tensor allows the sliding to the left or right.

FRA. Finition aluminium anodisé. Fixation au plafond, au sol, u au mur, vis fournie. Déplacer librement l'ensemble des câbles.

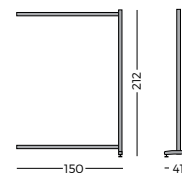
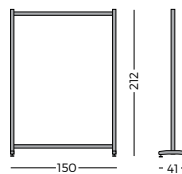
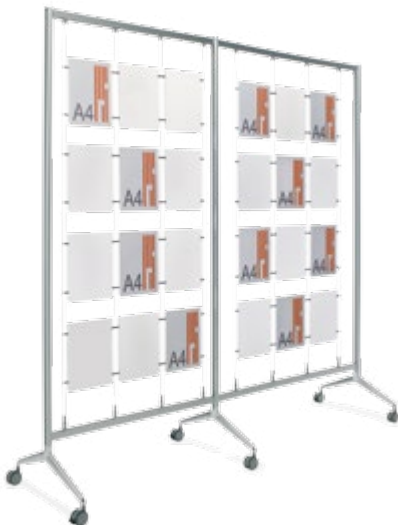

BASTIDOR

| REF | REF | └┘ |
|-----------------|-----------------|-----------|
| TN/90/R | TN/90/N | 212 x 90 |
| TN/110/R | TN/110/N | 212 x 110 |
| TN/150/R | TN/150/N | 212 x 150 |



AMPLIACIÓN

| REF | REF | └┘ |
|-----------------|-----------------|-----------|
| TN/90/R | TN/90/N | 212 x 90 |
| TN/110/R | TN/110/N | 212 x 110 |
| TN/150/R | TN/150/N | 212 x 150 |



880

PANELES DE REJILLA
GRID PANELS - PANNEAUX GRILLE

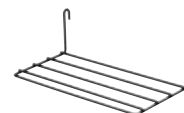
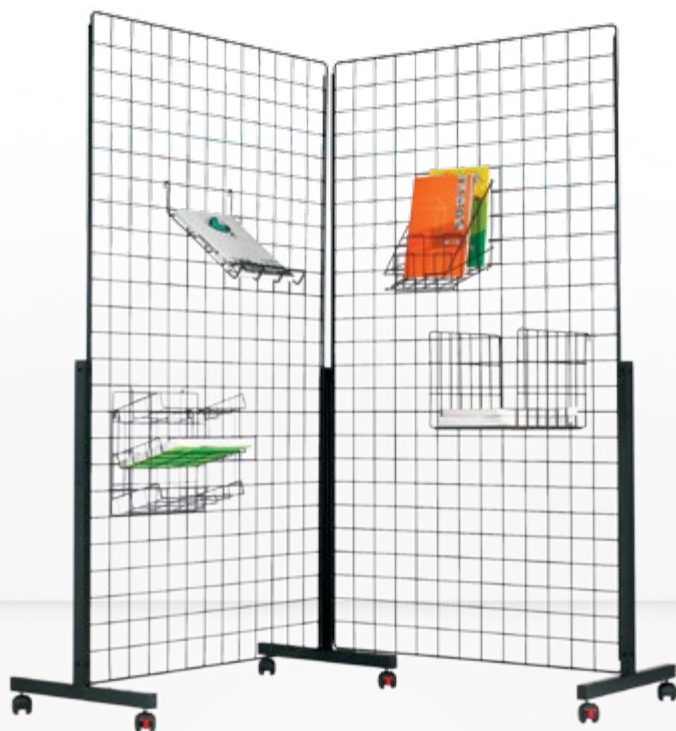
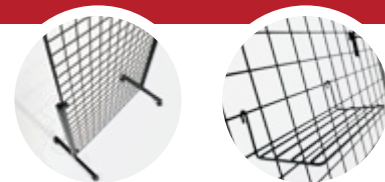

8801



8802

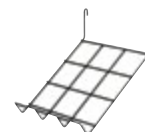

8803



8804



8808

| REF | DESC. | L | H |
|-----|---------|-----------|-----|
| 880 | Rejilla | 180 x 100 | 0,5 |
| 881 | Soporte | 95 x 50 | 4 |

| REF | DESC. | L | H |
|------|-----------|----------------|-----|
| 8801 | Bandeja | 9,5 x 30 x 14 | 0,5 |
| 8802 | Estante | 35 x 22 x 5 | 0,5 |
| 8803 | Estante | 5 x 27 x 38 | 0,5 |
| 8804 | Revistero | 29,5 x 22 x 24 | 0,5 |
| 8808 | Gancho | 9,5 x 3 x 27 | 0,5 |

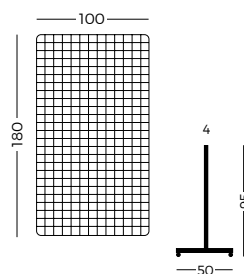

PANELES REJILLA

ESP. Paneles rejilla metálicos de color negro, contruidos con varilla de hierro de 0,5 cm. formando una malla de 7 cm. Puede colgarse a la pared o montarse con pies forma "T" con ruedas. Sobre el panel podemos situar una extensa gama de accesorios.

GRID PANELS

ENG. Black metallic grid panels which can be hung on walls or on "T" support frame (with castors). Black metallic stems have a diameter of 0,5 cm. and formed a 7 cm. net. Place a large range of accessories (also made with thin metallic stems).

PANNEAUX GRILLE

FRA. Panneaux grille noir métallique en fer 0,5 cm. formant une cloison de 7 cm. Grande flexibilité de configuration. Fixation murale ou sur piètement "T" avec roulettes. Sur les panneaux on peut fixer très facilement une gamme étendue d'accessoires.



CC-RAIL

RAIL PARA COLGAR CUADROS
RAIL FOR PICTURE HANGING - RAIL POUR ACCROCHER DES TABLEAUX



| REF | DESC. | L | H |
|--------|-------|---------|---|
| CC/150 | Rail | 3 x 200 | 1 |
| CC/1 | Cable | 200 | 1 |

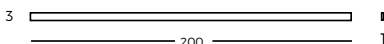

RAIL PARA CUADROS

ESP. Rail de aluminio mural color plata mate, para colgar cuadros. Permite cambiarlos sin tener que atornillarlos en la pared. Ideales para salas, galerías de arte, recepciones, etc. El kit de 200 cm. incluye un juego de 2 cables.

RAIL FOR PICTURE HANGING

ENG. Aluminium rail system for hanging up pictures on the wall. Matt silver colour. It enables different layout without drilling holes on the wall or using screws. Ideal for rooms,... The fixation kit includes two iron hooks and a set of two 200 cm cables.

RAIL POUR DES TABLEAUX

FRA. Rail mural en aluminium pour suspendre et exposer des tableaux. Couleur argent mat. Ce système permet de changer facilement la composition de tableaux. Idéal pour des salles, des galeries d'art, des réceptions, etc

DISPLAY

PORTAFOLLETOS DE METACRILATO
DOCUMENT HOLDERS - PORTE-BRO-
CHURES MÉTHACRYLATE



| REF | ┌ | ┆┆ | CAJA | U. |
|--------------|-----------|-----|----------------|----|
| A4/V3 | 33 x 22 | 3,5 | A4/V3/5 | 4 |
| A4/S | 30 x 22 | 3,5 | A4/S/10 | 20 |
| A4/M | 24,5 x 22 | 3,5 | A4/M/10 | 30 |

| REF | ┌ | ┆┆ | CAJA | U. |
|--------------|-----------|-----|----------------|----|
| A5/V3 | 23 x 16 | 3,5 | A5/V3/5 | 12 |
| A5/S | 20 x 16 | 3,5 | A5/S/10 | 40 |
| A5/M | 16,5 x 16 | 3,5 | A5/M/10 | 45 |

| REF | ┌ | ┆┆ | CAJA | U. |
|----------------|-----------|-----|------------------|----|
| A4/3/V3 | 23 x 11 | 3,5 | A4/3/V3/5 | 20 |
| A4/3/S | 20,5 x 11 | 3,5 | A4/3/S/10 | 50 |
| A4/3/M | 16,5 x 11 | 3,5 | A4/3/M/10 | 60 |

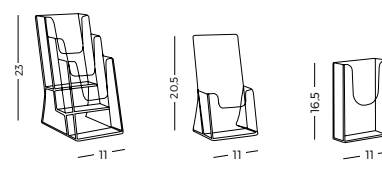
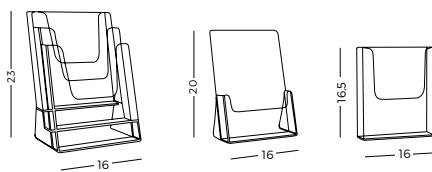
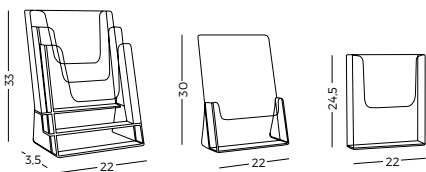

PORTAFOLLETOS DE METACRILATO

ESP. Expositores para folletos fabricados en metacrilato transparente de alta resistencia. La diversidad de diseños; mural, sobremesa simple y sobremesa triple, permiten obtener un perfecto soporte para cada necesidad.

DOCUMENT HOLDERS

ENG. High resistant transparent methacrylate document holders. Many different designs: wall, table and triple table that allow you to display all types of documents such as catalogues, brochures, cards for every need, etc.

PORTE-BROCHURES MÉTHACRYLATE

FRA. Porte-Brochures fabriqués en PMMA transparent de haute résistance. Gamme très étendue de designs: usage mural, usage comptoir simple et triple pour tous les besoins.



DISPLAY

DISPLAYS DE ACRÍLICO
ACRYLIC DISPLAYS - PORTE-VISUELS ACRYLIC



L

| REF | L | T |
|-------------------|-----------|----|
| BL/EX/0012 | 29,7 x 21 | A4 |
| BL/EX/0014 | 21 x 14,8 | A5 |

T

| REF | L | T |
|-------------------|-----------|----|
| BL/EX/0032 | 29,7 x 21 | A4 |
| BL/EX/0034 | 21 x 14,8 | A5 |

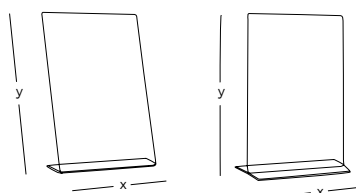

DISPLAY DE ACRÍLICO

ESP. Gama de portadocumentos fabricados en acrílico transparente de alta resistencia. Disponibles en formato "T" y "L" y cada uno de ellos en tamaño A4 y A5.

DISPLAYS ACRYLIC

ENG. Range document holder made of high strength transparent acrylic. Available as "T" and "L" and each of them in A4 and A5.

DISPLAY ACRYLIQUE

FRA. Gamme de supports et porte-documents en acrylique transparent de haute résistance. Disponible en "T" et "L" et disponibles en formats A4 et A5.

MODULPLAN

MOBILIARIO AUXILIAR
AUXILIAR FURNITURE
MOBILIER AUXILIAIRE



6000

PAPELERAS BASIC
BASIC BINS - CORBEILLES BASIC



| REF | L | L |
|------|--------------|----|
| 6001 | 31 x ø21,5 | 12 |
| 6002 | 31 x ø25,5 | 16 |
| 6003 | 39,5 x ø29,5 | 27 |

COLOR

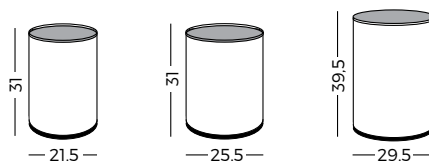

PAPELERA BASIC

ESP. Gama de papeleras metálicas lisas pintadas epoxi, provistas de aro inferior de PVC. Disponibles en 12, 16 y 27 litros. Color standard gris RAL 7035. Bajo pedido ver gama de colores.

BASIC BINS

ENG. Smooth metal wastebaskets Range epoxy painted, fitted with PVC bottom ring. Available in 12, 16 and 27 liters. Standard colour gray RAL 7035. Ask us for a special colour.

CORBEILLES BASIC

FRA. Gamme de corbeille à papier en métal époxy peint, équipée d'un anneau inférieure en PVC. Disponible en 12, 16 et 27 litres. Couleur standard gris RAL 7035. Consultez nous pour un coloris spécial.



6023

PAPELERA METÁLICA IGNÍFUGA
METALLIC FIREPROOF WASTEPAPER BIN - CORBEILLE IGNIFUGE EN MÉTAL



COLOR



| REF | L | L |
|-------------|------------|----|
| 6022 | 35 x ø27,5 | 21 |
| 6023 | 65 x ø27,5 | 39 |

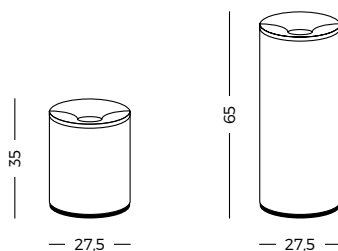

PAPELERA METÁLICA IGNÍFUGA

ESP. Papelera ignífuga de diferentes medidas. Debido a la forma del cabezal, el fuego generado en el interior se extingue rápidamente. En chapa metálica. Color standard gris RAL 7035. Bajo pedido ver gama de colores.

FIREPROOF WASTEPAPER BIN

ENG. Fire-retardant bin in different sizes. Due to the shape of the lid, the fire generated inside extinguishes itself quickly. Made from metal sheet. Standard colour gray RAL 7035. Ask us for a special colour.

CORBEILLE IGNIFUGE

FRA. Poubelle ignifuge de différentes mesures. En raison de la forme du couvercle, le feu généré à l'intérieur s'éteint rapidement. Fabriqué à partir de tôle. Couleur standard gris RAL 7035. Consultez nous pour un coloris spécial.

6056

PAPELERAS CÚBICAS
CUBIC WASTEPAPER BINS - CORBEILLE EN MÉTAL



| REF | L | → | L |
|--------|---------|----|----|
| 6056/1 | 40 x 30 | 30 | 36 |
| 6056/2 | 60 x 30 | 30 | 54 |
| 6056/3 | 80 x 30 | 30 | 72 |

COLOR

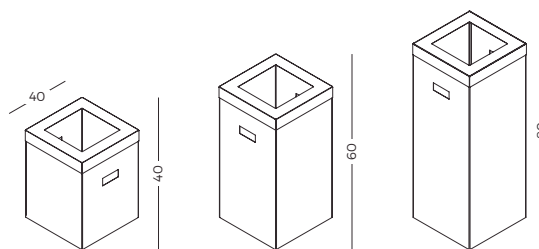

PAPELERA METÁLICA

ESP. Papelera sencilla de chapa metálica en 3 alturas para diferentes espacios. 40, 60 y 80 cm. Color standard blanco RAL 9003. Bajo pedido ver gama de colores.

METALLIC WASTEPAPER BIN

ENG. Simple sheet metal bin in 3 heights for different spaces. 40, 60 and 80 cm. Standard colour white RAL 9003. Ask us for a special colour.

CORBEILLE EN MÉTAL

FRA. Corbeille métallique simple de 3 hauteurs pour tous type d'espaces. 40, 60 et 80 cm. Couleur standard blanc RAL 9003. Consultez nous pour un coloris spécial.



SWING

PAPELERA METÁLICA
METALLIC WASTEPAPER BIN - CORBEILLE EN MÉTAL



COLOR



• /BL

| REF | L | → | L |
|-------------|-----------|----|----|
| 6030 | 65 x 31,5 | 26 | 41 |
| 6031 | 83 x 31,5 | 26 | 56 |

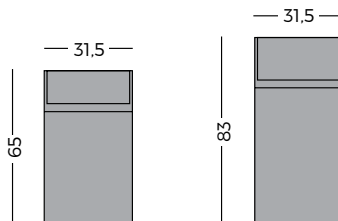

PAPELERA METÁLICA "SWING"

ESP. Papelera con apertura batiente de mediana capacidad ideal para centros comerciales. Disponible en INOX bajo pedido para exterior. Disponible 2 tamaños. Cabezal basculante.

METALLIC WASTEPAPER BIN "SWING"

ENG. Wastepaper bin with swing-open door of medium capacity. Ideal for shopping center. INOX version available for outdoors. 2 sizes available.

CORBEILLE "SWING" EN MÉTAL

FRA. Corbeille avec ouverture battante de capacité moyenne. Idéale centres commerciaux. Version INOX disponible pour l'extérieur. Disponible en 2 dimensions.

6055

PAPELERA DE 3 RESIDUOS
RECYCLING CONTAINER - CONTENEUR DE RECYCLAGE



| REF | L | → | L |
|------|---------|----|-----|
| 6055 | 70 x 75 | 35 | 120 |

COLOR

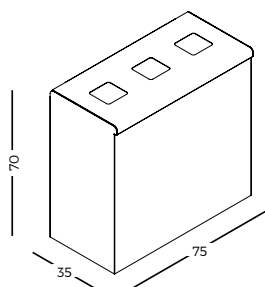

CORBILLE EN MÉTAL

ESP. Contenedor de reciclaje de 120 L de 3 residuos, con tapa abatible y 3 aros interiores para sujeción de las bolsas. Tapa superior con vinilo para la diferenciación de los residuos. Color standard blanco RAL 9003. Bajo pedido ver gama de colores.

RECYCLING CONTAINER

ENG. 120L recycling container for 3 types of waste, with hinged lid with pictogram for the different types of waste. Standard colour white RAL 9003. Ask us for a special colour.

CONTENEUR DE RECYCLAGE

FRA. Conteneur de recyclage de 120 L de 3 résidus, avec couvercle à charnière et 3 anneaux intérieurs pour la fixation des sacs. Couvercle supérieur avec pictos pour la différenciation des déchets.



6045

PAPELERA DE RECICLAJE
RECYCLE BINS - CORBEILLE DE RECYCLAGE



COLOR



/AZ /VD /AM

| REF | L | ↑ | L |
|------|-----------|----|----|
| 6045 | 26 x 36,5 | 81 | 76 |

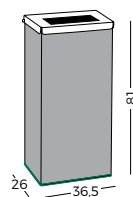
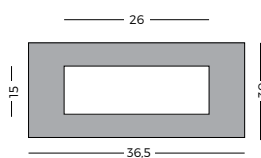

PAPELERA DE RECICLAJE

ESP. Papelera de reciclaje gris de 76 litros, con tapa abatible y aro interior para bolsa. Tapa superior disponible en 3 colores de reciclaje básicos. Ideal para oficinas, centros comerciales, etc...

RECYCLE BINS

ENG. Recycle Bin 76 liters grey colour, with hinged lid and inner ring for bag. Top cover available in 3 basic colours recycling. Ideal for offices, shopping malls, etc ...

CORBEILLE DE RECYCLAGE

FRA. Corbeille de recyclage de 76 litres, avec couvercle à charnière et bague intérieure pour le sac. Le couvercle est disponible en 3 couleurs de base de recyclage. Idéale pour les bureaux, les centres commerciaux...

6050

PAPERERAS DE PEDAL
 PEDAL BINS - CORBEILLES À PÉDALE



| REF | L | L |
|--------|----------|----|
| 6050/I | 32 x ø21 | 5 |
| 6051/I | 39 x ø25 | 12 |
| 6052/I | 45 x ø30 | 20 |
| 6053/I | 61 x ø30 | 30 |

ACABADO

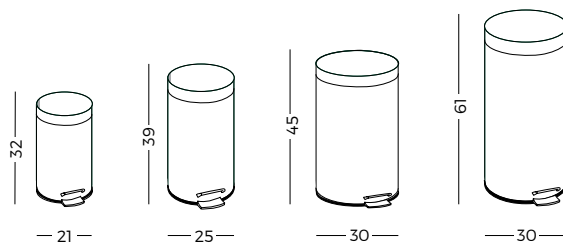

PAPERERAS DE PEDAL

ESP. Gama de papeleras metálicas con apertura de pedal. Incorporan cubeta de plástico con asa y están disponibles en 5, 12, 20 y 30 litros. Acero inoxidable.

PEDAL BINS

ENG. Range of metal bins with pedal opening. Incorporating plastic bucket and handle are available in 5, 12, 20, and 30 liters. Stainless steel.

CORBEILLES À PÉDALE

FRA. Gamme de corbeilles métalliques avec ouverture par pédale. Un seau en plastique intérieur avec poignée est disponibles en 5, 12, 20 et 30 litres. Acier inoxydable.



BL/MO

CENICEROS PARA EXTERIOR
OUTDOOR ASHTRAYS - CENDRIERS D'EXTÉRIEUR



BL/MO/0051



BL/MO/0050

| REF | L | H | L |
|------------|----------|----|------|
| BL/MO/0052 | 100 x 45 | 25 | 4.43 |

| REF | L | H | L |
|------------|---------|----|------|
| BL/MO/0050 | 25 x 19 | 25 | 1.48 |
| BL/MO/0051 | 35 x ø9 | 25 | 0.68 |

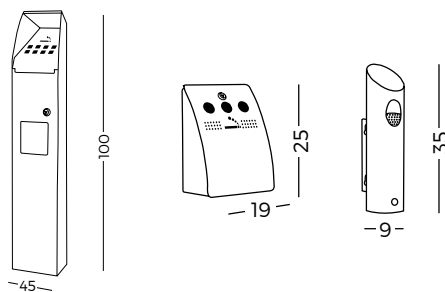

CENICEROS PARA EXTERIOR

ESP. Gama de ceniceros de exterior. 3 modalidades a suelo o a pared todos ellos provistos con cerradura de seguridad. Ideal para situar en las entradas de espacios públicos y privados donde no está permitido fumar.

PEDAL BINS

ENG. Range of outdoor ashtrays. 3 models, for floor or wall all provided with security lock. Ideal for entries and in public or private spaces where smoking is not permitted.

CORBEILLES À PÉDALE

FRA. Gamme de cendriers d'extérieurs. 3 modèles de sol ou mural tous fournis avec serrure de sécurité. Idéal pour les entrées dans les espaces publics et privés où fumer est interdit.



6120

PERCHEROS DE PARED
COAT RACKS - PORTE-MANTEAUX



| REF | L | H | ● |
|---------|---------|-----|---|
| 6120/3 | 10 x 41 | 2,5 | 3 |
| 6120/4 | 10 x 55 | 2,5 | 4 |
| 6120/6 | 10 x 85 | 2,5 | 6 |
| 6120/6R | 24 x 81 | 2,5 | 6 |

COLOR

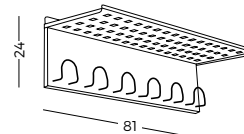
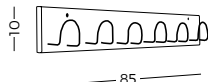
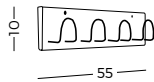
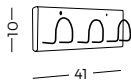

PERCHEROS DE PARED

ESP. Colección de percheros murales metálicos pintados epoxi gris. Diferentes tamaños y disponible en 3, 4 y 6 perchas. Ideales tanto como para el mundo de la oficina como el habitat.

COAT RACKS

ENG. Wall racks collection painted in grey epoxy. Different sizes and available in 3,4 and 6 hangers. Ideal as to the world of office as the habitat...

PORTE-MANTEAUX

FRA. Gamme de portes manteaux métalliques finition en époxy gris. Différentes dimensions, avec 3,4 et 6 crochets. Idéal pour les bureaux et l'habitat.



ECO/T

PERCHEROS
COAT STAND - PORTE-MANTEAU



COLOR



/NG /BL

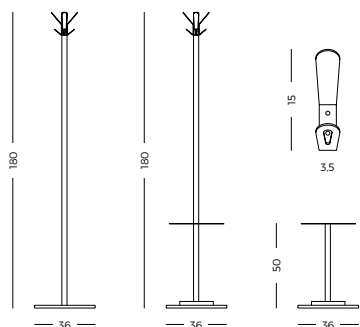

PERCHERO METÁLICO

ESP. Perchero metálico de tubo redondo de $\phi 4$ cm. y de gran ligereza y estabilidad gracias a su base. 4 ganchos dobles en su parte superior y pintados en colores negro y blanco. Ideal para la oficina y el habitat. Disponible en versión mural de 1, 3,4 o 6 perchas.

METALLIC COAT STAND

ENG. Metal coat stand with round tube $\phi 4$ cm. and of great lightness and stability thanks to its base. 4 double hooks on top and painted in black and white colors. Ideal for the office and habitat. Available in wall version of 1, 3,4 or 6 hangers.

PORTE-MANTEAU MÉTALLIQUE

FRA. Porte-manteau en métal avec tube rond de $\phi 4$ cm, de grande légèreté et stabilité grâce à sa base ronde lestée. 4 crochets doubles sur le dessus peint de couleur noir ou blanc. Idéal pour le bureau et l'habitat. Disponible en version murale de 1, 3, 4 ou 6 patères.

| REF | DESC. | L | ● |
|----------|----------------------|-----------------|---|
| EC/02 | Perchero | 180 x $\phi 36$ | 8 |
| EC/12 | Perchero - Paragüero | 180 x $\phi 36$ | 8 |
| EC/P | Paragüero | 50 x $\phi 36$ | - |
| EC/02/M1 | Perchero mural | 15 x 3,5 | 1 |
| EC/02/M3 | Perchero mural | 15 x 20,5 | 3 |
| EC/02/M4 | Perchero mural | 15 x 29 | 4 |
| EC/02/M6 | Perchero mural | 15 x 42,5 | 6 |





PERCHEROS

PERCHEROS
COAT STANDS - PORTE-MANTEAUX



| REF | L | ● | COLOR |
|-------|-----------|---|-----------|
| 6100 | 177 x ø38 | 8 | /GR |
| 6110 | 165 x ø30 | 5 | /GR |
| EC/03 | 177 x ø38 | 3 | /BL - /NG |



COLOR

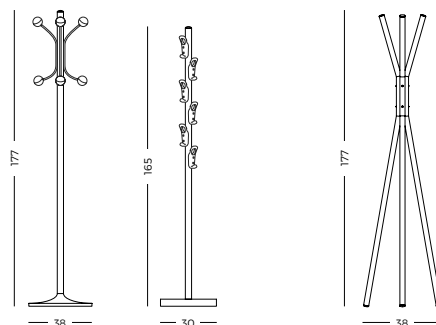

PERCHEROS METÁLICOS

ESP. Gama de percheros metálicos de tubo redondo. 6100 y 6110 en base redonda, con 8 y 6 perchas superiores respectivamente. EC/03 es desmontable, en tubo redondo doblado.

METALLIC COAT STANDS

ENG. Range of metal round coat stands. 6100 and 6110 in round base, with 8 and 6 upper hangers respectively. EC/03 in 3 round bent tubes.

PORTE-MANTEAUX MÉTALLIQUES

FRA. Gamme de portemanteaux ronds en métal. 6100 et 6110 dans la base ronde, avec 8 et 6 cintres supérieurs, respectivement. EC/03 en 3 tubes coudés ronds.



ECO/T

PERCHEROS
COAT STAND - PORTE-MANTEAU



COLOR



/NG /BL

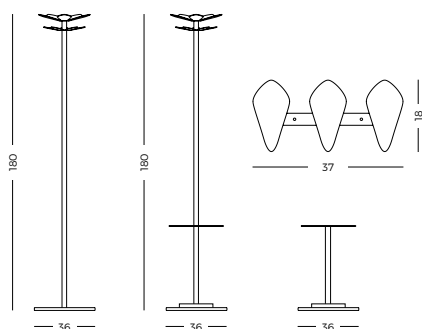

| REF | DESC. | L | ● |
|----------|----------------------|-----------|----|
| EC/04 | Perchero | 180 x ø36 | 10 |
| EC/14 | Perchero - Paragüero | 180 x ø36 | 10 |
| EC/P | Paragüero | 50 x ø36 | - |
| EC/04/M3 | Perchero mural | 18 x 37 | 3 |
| EC/04/M4 | Perchero mural | 18 x 51 | 4 |
| EC/04/M6 | Perchero mural | 18 x 79 | 6 |

PERCHERO METÁLICO

ESP. Perchero metálico de tubo redondo de ø3cm, ligero y estable gracias a su base. 10 perchas en su parte superior. Pintado en colores negro y blanco. Disponible en versión mural de 3, 4 o 6 perchas.

METALLIC COAT STAND

ENG. Metallic coat rack with round ø3cm tube, light and stable thanks to its base. 10 hangers on top. Painted in black and white colors. Available in wall version of 3, 4 or 6 hangers.

PORTE-MANTEAU MÉTALLIQUE

FRA. Porte-manteau métallique fabriqué avec un tube rond de ø3cm, léger et stable grâce à sa base lestée. 10 patères sur le dessus. Couleur noire ou blanche. Disponible en version murale de 3, 4 ou 6 patères.

TS

PERCHEROS DE BASTIDOS
COAT RACKS - PORTE-MANTEAUX



| REF | L | ↑ | ⇄ |
|-----------|----------|----|-----|
| TS/PER/MT | 200 x 65 | 25 | 4,5 |
| TS/PER/MX | 200 x 62 | 25 | 4,5 |



| REF | L | ↑ | ⇄ |
|----------|-----------|----|-----|
| TS/BUR/R | 174 x 120 | 53 | 4,5 |

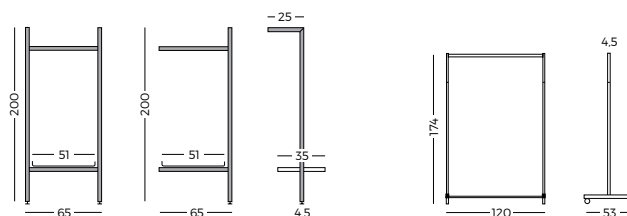

PERCHEROS DE PARED

ESP. Percheros fabricados con perfil de aluminio pata mate. TS/PER se fija a la pared mediante los brazos separadores y se apoya al suelo. Disponible kit de ampliación: Ref. TS/PER/MX. TS/BUR/R es un bastidor con ruedas demontable.

COAT HANGERS

ENG. Coat hanger in grey aluminium. TS/PER fixed to the wall and floor. Hanging rod for hangers and lower tray for bags or helmets included. Extension kit available. TS/BUR/R with casters and removable.

PORTE-MANTEAUX

FRA. Porte-manteux en aluminium. TS/PER avec un point de fixation mural et appui au sol sur piétement. Kit d'extension disponible. Barre de suspension pour cintres et tablette inférieure pour sacs et casques inclus. TS/BUR/R sur roulettes et amovible.



TS

PERCHEROS DE BASTIDOS
COAT RACKS - PORTE-MANTEAUX



| REF | L | ↑ | ⇄ |
|-----------|-----------|----|-----|
| TS/PER/R | 174 x 120 | 53 | 4,5 |
| TS/PER/RB | 174 x 120 | 53 | 4,5 |

| REF | DESC. | ↑ |
|-------|--------|---------|
| PER/I | Percha | 17 x 40 |

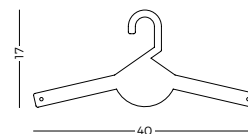
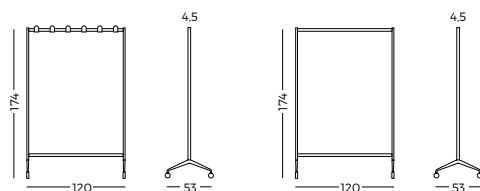

PERCHEROS DE PARED

ESP. Perchero con ruedas (2 con freno) fabricados con perfil de aluminio anodizado plata mate TEN. El perchero incluye 6 brazos dobles (12 perchas) y 2 bases de plexiglass blanco en la parte inferior.

COAT HANGERS

ENG. Coat hanger TEN made from anodized aluminium on casters with brakes. 6 double pegs (12 total) and 2 lower trays made from plexiglass.

PORTE-MANTEAUX

FRA. Portemanteau sur roulettes (dont 2 avec frein) en aluminium anodisé TEN. 6 patères doubles et 2 tablettes inférieures pour sacs et casques en plexiglass.

TEN

SISTEMA DE ESTANTERÍA
SHELF MODULAR SYSTEM - ETAGÈRE MODULAIRE SYSTEM



| REF | DESC. | L | H |
|-----------|----------|-----------|-----|
| TS/242/P | Aluminio | 220 x 25 | - |
| TS/242/EI | Estante | 35 x 66,5 | 0,2 |

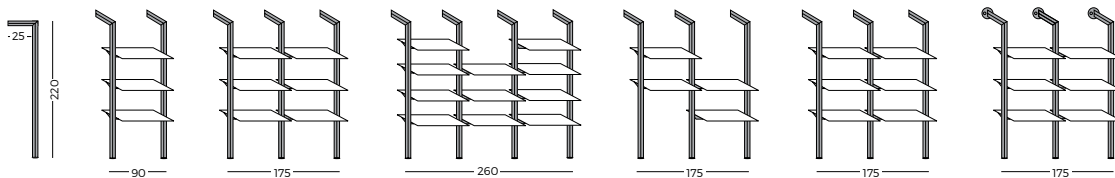

SISTEMA DE ESTANTERÍA "TEN"

ESP. Perfilera de aluminio anodizada plata mate para equipar comercios, vestidores, oficinas, etc... Gracias a su modularidad permite confeccionar estantería de la medida deseada. Se compone de perfil vertical, juego de soportes graduable y estantes.

MODULAR SYSTEM "TEN"

ENG. Modular shelf in anodized aluminium. Ideal for offices, shops, cloakrooms...(various layouts possible). Composed of a vertical profile with wall fixation and a set of brackets. Various colors and finishings.

ETAGÈRE MODULAIRE SYSTEM "TEN"

FRA. Etagère modulaire en aluminium anodisé "Ten", idéale pour les bureaux, commerces, vestiaires... (nombreuses configurations possibles). Composée d'un profil vertical avec fixation murale, d'un jeu de pattes de fixation réglables, diverses finitions et couleurs.



TROLLEY

MESAS DE PROYECCIÓN
PROJECTOR TROLLEYS - TABLES DE RÉTRPROJECTION



COLOR



| REF | L | ↑ | ↓ |
|-----|---------|-------|-----|
| MM | 60 x 55 | 60/95 | 1,9 |
| MP | 60 x 55 | 60/95 | 1,9 |

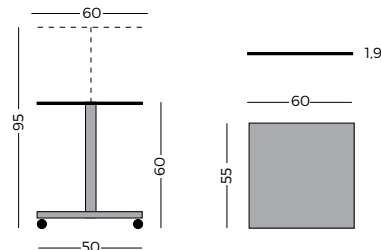
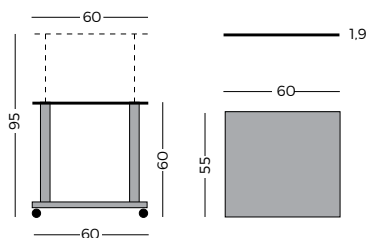

MESAS DE PROYECCIÓN

ESP. Mesa de proyección cómoda y ligera, con ruedas multidireccionales, provistas de freno las delanteras. Toda la gama de mesas tienen la estructura metálica pintada en color gris, y los tableros son de madera melaminada.

PROJECTOR TROLLEYS

ENG. With a modern design suitable for all OHPs, this functional grey metallic mobile trolley features a laminated tabletop for storage of accessories and equipment, and 4 fully circular castors (lockable front castors).

TABLES DE RÉTRPROJECTION

FRA. Table de projection légère et stable. Conception en métal gris et plateau en mélaminé. Equipée de 4 roulettes pivotantes dont 2 avec freins, qui assurent mobilité et stabilité. Plateau télescopique réglable en hauteur. Idéale pour n'importe quel type de projecteur.

PFA

PANELES FONOABSORBENTES
SOUND ABSORBING PANELS - TABLEAUX PHONO-ABSORBANTS

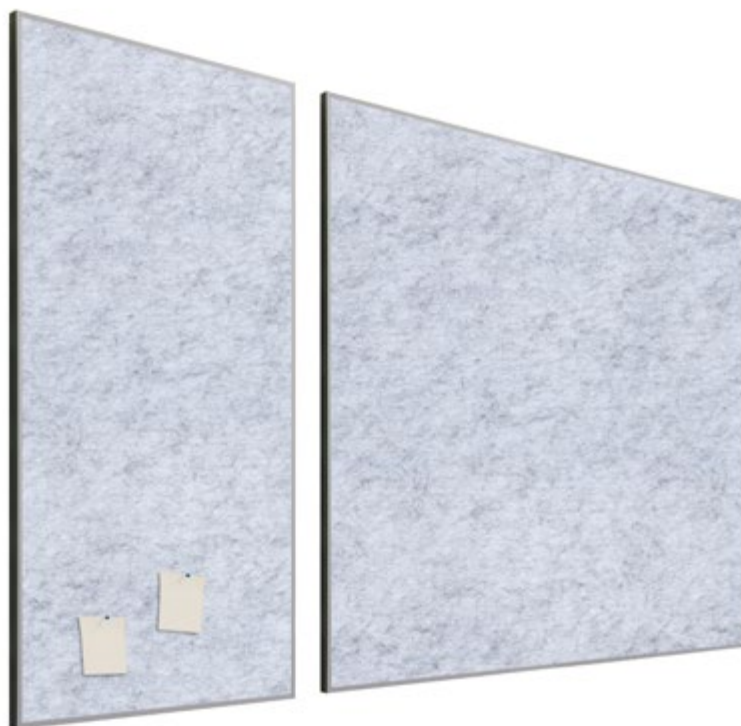

| REF | L | H | alpha m |
|-------|-----------|-----|---------|
| PFA/1 | 30 x 60 | 2,3 | 0,25 |
| PFA/2 | 60 x 60 | 2,3 | 0,25 |
| PFA/3 | 60 x 120 | 2,3 | 0,25 |
| PFA/4 | 120 x 120 | 2,3 | 0,25 |

COLOR

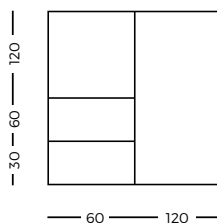

PANELES FONOABSORBENTES

ESP. Panel fonoabsorbente enmarcado con perfil de aluminio anodizado Mini en color plata mate. Fabricado con alto porcentaje de material reciclado: 60% fibras de poliéster reciclado de botellas de plástico PET y 40% de nuevas fibras de poliéster. Propiedades acústicas: alpha m: 0,25. NRC: 0,30.

SOUND-ABSORBING PANELS

ENG. Sound-absorbing panel framed with anodised aluminum profile Mini in matt silver. Manufactured with a high percentage of recycled material: 60% polyester fiber recycled from PET plastic bottles and 40% new polyester fibers. Acoustic properties: alpha m: 0.25. NRC: 0.30.

TABLEAUX PHONO-ABSORBANTS

FRA. Panneau insonorisant fabriqué avec un pourcentage élevé de matériaux recyclés: 60% de fibres de polyester recyclées provenant de bouteilles en plastique PET et 40% de fibres de polyester neuves. Propriétés acoustiques: alpha m: 0,25. NRC: 0,30.



PFA

PANELES FONOABSORBENTES
SOUND ABSORBING PANELS - TABLEAUX PHONO-ABSORBANTS



| REF | DESC. | L | H | alpha m |
|--------|------------|----------|-----|---------|
| PFA/C2 | Techo | 60 x 60 | 0,9 | 0,25 |
| PFA/S3 | Suspendido | 60 x 60 | 2,3 | 0,25 |
| PFA/S4 | Suspendido | 120 x 60 | 2,3 | 0,25 |

COLOR

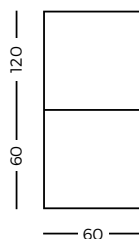

PANELES FONOABSORBENTES

ESP. Panel fonoabsorbente para techo o suspendido. Fabricado con alto porcentaje de material reciclado: 60% fibras de poliéster reciclado de botellas de plástico PET y 40% de nuevas fibras de poliéster. Propiedades acústicas: alpha m: 0,25. NRC: 0,30.

SOUND-ABSORBING PANELS

ENG. Sound-absorbing panel for the ceiling or suspended. Manufactured with a high percentage of recycled material: 60% polyester fiber recycled from PET plastic bottles and 40% new polyester fibers. Acoustic properties: alpha m: 0,25. NRC: 0,30.

TABLEAUX PHONO-ABSORBANTS

FRA. Panneau insonorisant fabriqué avec un pourcentage élevé de matériaux recyclés: 60% de fibres de polyester recyclées provenant de bouteilles en plastique PET et 40% de fibres de polyester neuves. Propriétés acoustiques: alpha m: 0,25. NRC: 0,30.



PFA

PANELES FONOABSORBENTES
SOUND ABSORBING PANELS - TABLEAUX PHONO-ABSORBANTS



COLOR



/NG /AN /GR /NJ /AM /AZ /VD

| REF | W | L | H | alpha m |
|--------|-----|-----------|----|---------|
| PFA/T3 | 190 | 60 x 120 | 53 | 0,25 |
| PFA/T4 | 190 | 120 x 120 | 53 | 0,25 |

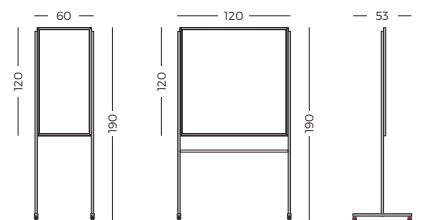

PANELES FONOABSORBENTES

ESP. Panel fonoabsorbente enmarcado con perfil de aluminio anodizado Mini en color plata mate y con soporte T. Fabricado con alto porcentaje de material reciclado: 60% fibras de poliéster reciclado de botellas de plástico PET y 40% de nuevas fibras de poliéster. Propiedades acústicas: alpha m: 0,25. NRC: 0,30.

SOUND-ABSORBING PANELS

ENG. Sound-absorbing panel framed with anodised aluminum profile Mini in matt silver with T support. Manufactured with a high percentage of recycled material: 60% polyester fiber recycled from PET plastic bottles and 40% new polyester fibers. Acoustic properties: alpha m: 0.25. NRC: 0.30.

TABLEAUX PHONO-ABSORBANTS

FRA. Panneau insonorisant avec support T fabriqué avec un pourcentage élevé de matériaux recyclés: 60% de fibres de polyester recyclées provenant de bouteilles en plastique PET et 40% de fibres de polyester neuves. Propriétés acoustiques: alpha m: 0,25. NRC: 0,30.

LIMIT

MAMPARA MODULAR
MODULAR PARTITION - CLOISON MODULAIRE

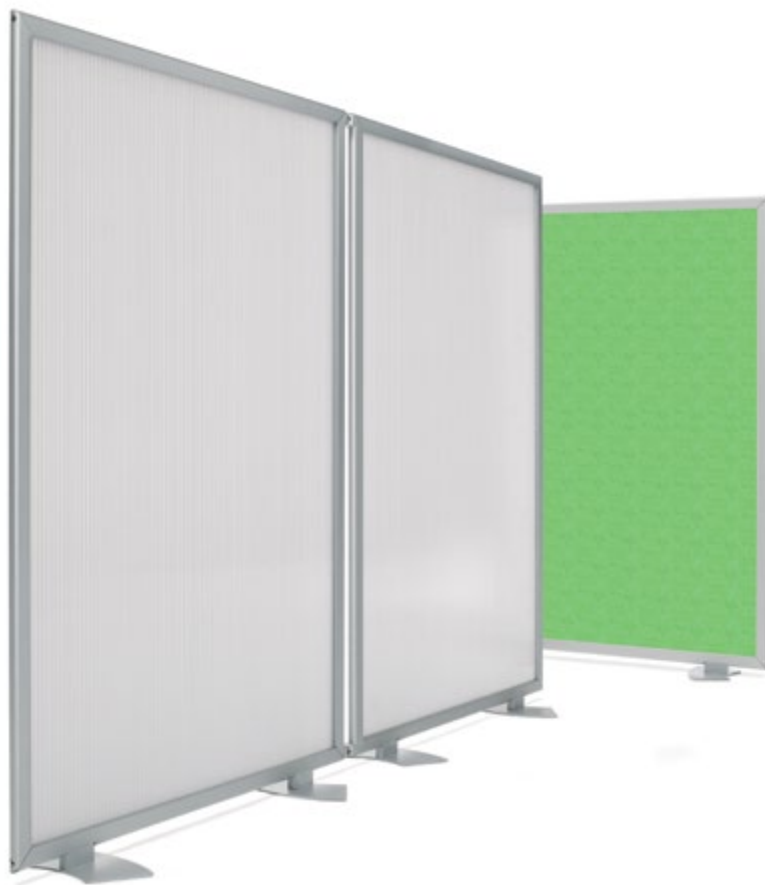

| REF | L | H | + |
|-----------|-----------|-----|---|
| 300/1/... | 120 x 100 | 122 | 2 |
| 300/2/... | 150 x 100 | 152 | 2 |
| 300/3/... | 180 x 100 | 182 | 2 |

| REF | L | H |
|---------|-------|---|
| 300/K | 2 x 5 | 2 |
| 300/K/4 | 5 x 5 | 4 |

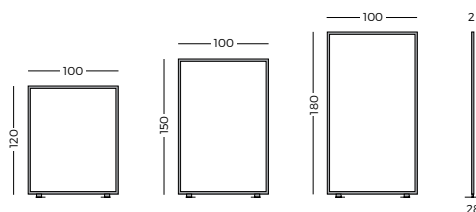

MAMPARA MODULAR "LIMIT"

ESP. Mampara modular "Limit" fabricada con perfil de aluminio anodizado mate y pies trapezoidales metálicos pintados en gris. Graduable con apertura de grados necesaria. Disponible en pizarra lacada blanca rotulable, policarbonato acanalado y panel acústico disponible en 7 colores.

MODULAR PARTITION "LIMIT"

ENG. Modular partition with aluminium structure and metallic supports. Different layouts possible: in a line or in staggered rows... Available with lacquered whiteboard, corrugated polycarbonate and available in 7 colours of acoustic panel.

CLOISON MODULAIRE "LIMIT"

FRA. Cloison modulaire avec structure en aluminium et pieds métalliques. Modulable pour configurations en ligne, en quinconce... Disponible en finition tableau blanc laqué, polycarbonate rainuré et disponible en 7 couleurs de panneau acoustique..



PIZARRA

| REF | L | -- | - - |
|-----------------|-----------|-----|-----|
| 300/1/PI | 120 x 100 | 122 | 2 |
| 300/2/PI | 150 x 100 | 152 | 2 |
| 300/3/PI | 180 x 100 | 182 | 2 |



FONOABSORBENTE

| REF | L | -- | - - |
|-----------------|-----------|-----|-----|
| 300/1/FA | 120 x 100 | 122 | 2 |
| 300/2/FA | 150 x 100 | 152 | 2 |
| 300/3/FA | 180 x 100 | 182 | 2 |



POLICARBONATO

| REF | L | -- | - - |
|-----------------|-----------|-----|-----|
| 300/1/PX | 120 x 100 | 122 | 2 |
| 300/2/PX | 150 x 100 | 152 | 2 |
| 300/3/PX | 180 x 100 | 182 | 2 |



ESP. Crea espacios dentro de la oficina para poder crear un ambiente de trabajo adecuado.

ENG. Design spaces within the office to creating a suitable work environment.

FRA. Créez des espaces afin d'adapter et créer des ambiances de travail différentes.

FONOABSORBENTE



NEGRO /NG



ANTRACITA /AN



BLANCO /GR



NARANJA /NJ



VERDE /VD



AMARILLO /AM



AZUL /AZ

ACABADOS



PIZARRA /PI



POLICARB. /PX

TEN-LIMIT

MAMPARA MODULAR
MODULAR PARTITION - CLOISON MODULAIRE



| REF | L | ↑ | ↑↑ |
|------------|-----------|-----|-----|
| TL/150/... | 150 x 100 | 175 | 4,5 |
| TL/180/... | 180 x 100 | 205 | 4,5 |

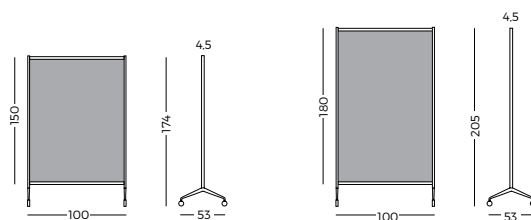

MAMPARA TEN-LIMIT

ESP. Sistema de mampara modular fabricada con perfil de aluminio color plata y estructura provista de pies de fundición con ruedas y freno. Disponible en pizarra lacada blanca rotulable, policarbonato acanalado y panel acústico disponible en 7 colores.

TEN-LIMIT PARTITION SYSTEM

ENG. Modular partition system made of silver gray aluminium profile and a structure with cast feet fitted with wheels and brakes. Available with lacquered whiteboard, corrugated polycarbonate and available in 7 colours of acoustic panel.

CLOISON TEN-LIMIT

FRA. Système de cloison modulaire sur cadre en aluminium et pieds en fonte gris, équipés de roulettes et de freins. Disponible en finition tableau blanc laqué, polycarbonate rainuré et disponible en 7 couleurs de panneau acoustique.



PIZARRA

| REF | L | ↑ | ± |
|--------------|-----------|-----|-----|
| TL/150/PI | 150 x 100 | 175 | 4,5 |
| TL/150/XF/PI | 150 x 100 | 175 | 4,5 |
| TL/180/PI | 180 x 100 | 205 | 4,5 |
| TL/180/XF/PI | 180 x 100 | 205 | 4,5 |



FONOABSORBENTE

| REF | L | ↑ | ± |
|--------------|-----------|-----|-----|
| TL/150/FA | 150 x 100 | 175 | 4,5 |
| TL/150/XF/FA | 150 x 100 | 175 | 4,5 |
| TL/180/FA | 180 x 100 | 205 | 4,5 |
| TL/180/XF/FA | 180 x 100 | 205 | 4,5 |



POLICARBONATO

| REF | L | ↑ | ± |
|--------------|-----------|-----|-----|
| TL/150/PX | 150 x 100 | 175 | 4,5 |
| TL/150/XF/PX | 150 x 100 | 175 | 4,5 |
| TL/180/PX | 180 x 100 | 205 | 4,5 |
| TL/180/XF/PX | 180 x 100 | 205 | 4,5 |



ESP. Crea espacios dentro de la oficina para poder crear un ambiente de trabajo adecuado.

ENG. Design spaces within the office to creating a suitable work environment.

FRA. Créez des espaces afin d'adapter et créer des ambiances de travail différentes.

FONOABSORBENTE



NEGRO /NG



ANTRACITA /AN



BLANCO /GR



NARANJA /NJ



VERDE /VD



AMARILLO /AM



AZUL /AZ

ACABADOS



PIZARRA /PI



POLICARB. /PX

750

MAMPARA MODULAR
MODULAR PARTITION - CLOISON MODULAIRE

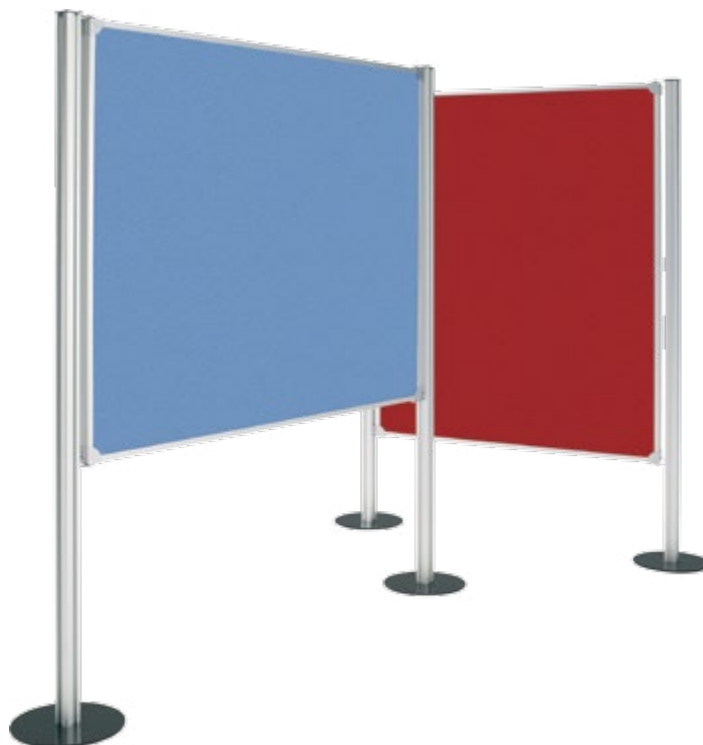

TAPIZADO



/NG /GR /CR /OC /NJ /RJ /BD /AZ /AC /VC /VM /VD

REF L H

750/... 120 x 150 3,5



ACABADO



CORK PIZARRA

REF L H

770/10 190 x ø36 5

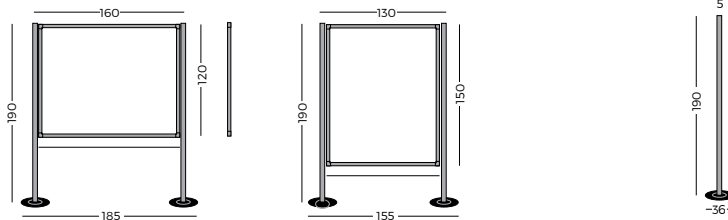

MAMPARA MODULAR 750

ESP. Mampara modular muy ligera, construida con un núcleo central de nido de abeja, enmarcada con perfil de aluminio con cantoneras de color gris. Disponible en pizarra lacada blanca rotulable, corcho y tapizado. Amplia gama de aplicaciones como: Exposiciones, ferias, convenciones, etc.

750 PARTITION SYSTEM

ENG. Light modulated felt boards with aluminium frame, grey corners and honeycomb wood. Variety of applications, such as expositions, fairs, conventions, etc... Boards are 120 x 150 cm. and you can mount the support vertically or horizontally.

CLOISONS MODULAIRES 750

FRA. Cloison modulaire très légère fabriquée en carton nid d'abeille, avec encadrement en aluminium et coins en plastique gris. 120 x 150. Montage et transport facile. Idéale pour les expositions, séparations d'espaces, foires, conventions, etc...



PIZARRA

REF L H

750/P 120 x 150 3.5



TAPIZADO

REF L H

750/T 120 x 150 3.5



CORCHO

REF L H

750/C 120 x 150 3.5



COMBINACIONES

Bajo pedido - Under order - Sous commande

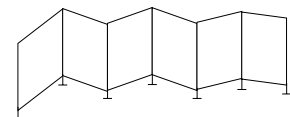
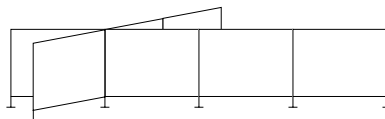
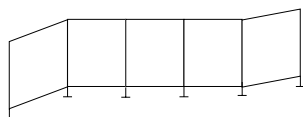

SEP

SEPARADOR DE ESCRITORIO
DESKTOP SEPARATOR - SÉPARATEURS DE BUREAU



| REF | L | H |
|------------|----------|-----|
| SEP/FA/80 | 40 x 80 | 4,6 |
| SEP/FA/120 | 40 x 120 | 4,6 |
| SEP/FA/140 | 40 x 140 | 4,6 |
| SEP/FA/160 | 40 x 160 | 4,6 |
| SEP/FA/180 | 40 x 180 | 4,6 |
| SEP/FA/200 | 40 x 200 | 4,6 |

COLOR

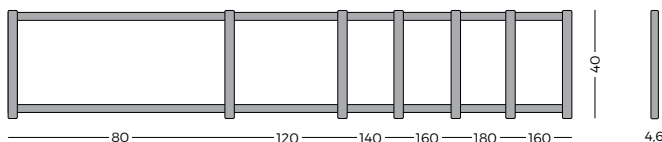

* Sujeción (x2)

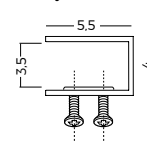

SEPARADOR DE ESCRITORIO

ESP. Colección de separadores de sobremesa acústicos tapizados con tela disponible en 6 colores. Perfil de aluminio anodizado plata mate. Conjunto fonoabsorbente.

DESKTOP SEPARATOR

ENG. Collection of acoustic desktop separators with 6 different colours of fabric. Profile of anodized aluminium matt silver. Sound absorbing assembly.

SÉPARATEURS DE BUREAU

FRA. Collection de cloisons et séparateurs acoustiques de bureau, disponible en toile avec 6 couleurs au choix. Profil en aluminium mat anodisé argent mat, avec ensemble amortissant.



ATR

ATRIL PARA CONFERENCIAS
CONFERENCE LECTERNS - PUPITRE POUR CONFÉRENCES



| REF | L | ↓ |
|-------|---------|-----|
| ATR/1 | 51 x 31 | 122 |
| ATR/2 | 45 x 32 | 110 |

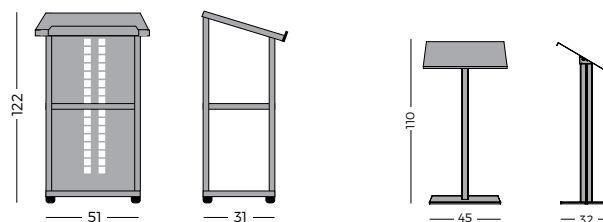

ATRIL PARA CONFERENCIAS

ESP. Atriles para conferencias. ATR/1 fabricado con estructura de aluminio anodizado en plata mate y plancha perforada del mismo color. El sobre inclinado, la base y el estante son de madera de haya. La base incluye 4 niveladores regulables en altura. ATR/2 fabricado en chapa de hierro y aluminio anodizado.

CONFERENCE LECTERN

ENG. Conference lecterns. ATR/1 made from silver aluminium anodized structure and perforated plate in the same colour. The inclined top, base and shelf are made of beech wood. The base contains 4 height adjustable levelings to level out the ground drops. ATR/2 made from iron sheets and anodized aluminium.

PUPITRE POUR CONFÉRENCES

FRA. Pupitres de conférences. ATR/1 fabriqué avec une structure en aluminium anodisée de couleur argent mat. La tablette inclinée ainsi que la base sont en bois d'hêtre. La base à 4 niveleurs réglables en hauteur. Idéal pour les salles de formation et de conventions. ATR/2 structure métallique et aluminium anodisé.

VTR

VITRINAS DE PIÉ
VITRINA DE PIE -VITRINA DE PIE



| REF | L | H |
|-------|----------|----|
| VTR/1 | 40 x 40 | 40 |
| VTR/2 | 80 x 40 | 40 |
| VTR/3 | 120 x 40 | 40 |
| VTR/4 | 160 x 40 | 40 |
| VTR/5 | 200 x 40 | 40 |

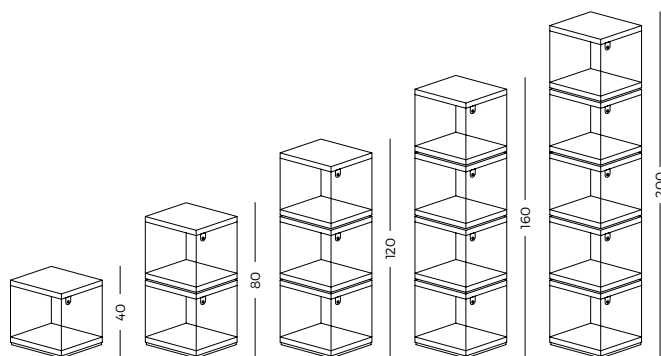

COLOR



VITRINAS

ESP. Vitrina expositora cuadrada de chapa metálica y laterales de PMMA. Vista interior de 360°. Envío de la estantería desmontada. Puerta abatiente con llave. Disponible en 5 alturas estandar y 2 colores.

DISPLAY CASE

ENG. Display case made from sheet metal and PMMA sides. 360° visible interior. Folding door with key. Available in 5 standard heights and 2 colors. Easy assembly. Ships disassembled.

VITRINE

FRA. Vitrine en tôle et côtés en PMMA. 360° intérieur visible. Porte pliante avec clé. Disponible en 5 hauteurs standard et 2 couleurs. Assemblage facile. Navires démontés.



VTR

VITRINAS DE PIÉ
VITRINA DE PIE -VITRINA DE PIE



COLOR



/AN /BL

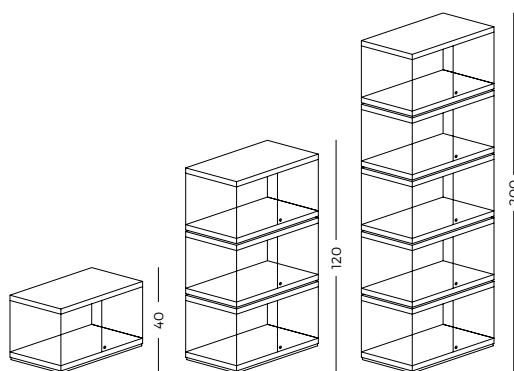

| REF | L | H |
|---------------|----------|----|
| VTR/11 | 40 x 80 | 40 |
| VTR/12 | 80 x 80 | 40 |
| VTR/13 | 120 x 80 | 40 |
| VTR/14 | 160 x 80 | 40 |
| VTR/15 | 200 x 80 | 40 |



VITRINAS

ESP. Vitrina expositora rectangular de chapa metálica y laterales de PMMA. Vista interior de 360°. Envío de la estantería desmontada. Puerta abatiente con llave. Disponible en 5 alturas estandar y 2 colores.

DISPLAY CASE

ENG. Display case made from sheet metal and PMMA sides. 360° visible interior. Folding door with key. Available in 5 standard heights and 2 colors. Easy assembly. Ships disassembled.

VITRINE

FRA. Vitrine en tôle et côtés en PMMA. 360° intérieur visible. Porte pliante avec clé. Disponible en 5 hauteurs standard et 2 couleurs. Assemblage facile. Navires démontés.

VTR

VITRINAS DE PIÉ
VITRINA DE PIE -VITRINA DE PIE

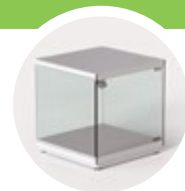

| REF | DESC. | L | H |
|------------------|------------|---------|----|
| VTR/40/B | Base | 40 x 40 | 40 |
| VTR/40/I | Intermedio | 40 x 40 | 40 |
| VTR/40/T | Tapa | 40 x 40 | 40 |
| VTR/80/B | Base | 40 x 80 | 40 |
| VTR/80/I | Intermedio | 40 x 80 | 40 |
| VTR/80/T | Tapa | 40 x 80 | 40 |
| VTR/40D/B | Base | 80 x 40 | 40 |
| VTR/40D/I | Intermedio | 80 x 40 | 40 |
| VTR/40D/T | Tapa | 80 x 40 | 40 |

COLOR

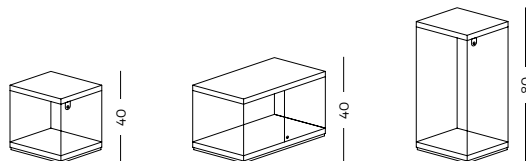

VITRINAS

ESP. Vitrina expositora cuadrada de chapa metálica y laterales de PMMA. Vista interior de 360°. Envío de la estantería desmontada. Puerta abatiente con llave. Montaje personalizado.

DISPLAY CASE

ENG. Display case made from sheet metal and PMMA sides. 360° visible interior. Folding door with key. Easy assembly. Ships disassembled. Customizable.

VITRINE

FRA. Vitrine en tôle et côtés en PMMA. 360° intérieur visible. Porte pliante avec clé. Personnalisation disponible. Assemblage facile. Navires démontés.



VTR

VITRINAS DE PIÉ
VITRINA DE PIE -VITRINA DE PIE



COLOR



| REF | DESC. | L | H |
|--------|-------------------|----------|----|
| VTR/L | Soporte Mural | 40 x 40 | 40 |
| VTR/P1 | Soporte Pié | 120 x 40 | 40 |
| VTR/P2 | Soporte Pié Doble | 120 x 80 | 40 |

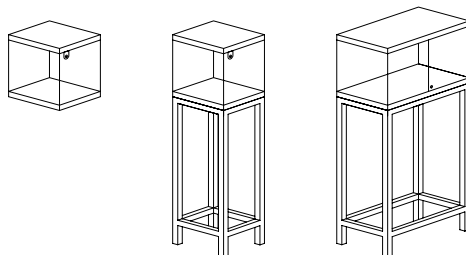

Vitrina no incorporada
Display case not included
Vitrine non incluse



VITRINAS

ESP. Accesorios para vitrina expositora: soporte mural en forma de L para vitrina individual. Soporte de pié para vitrinas individuales o dobles.

DISPLAY CASE

ENG. Accessories for display case: L-shaped wall mount for individual showcase. Support for individual or double showcases.

VITRINE

FRA. Accessoires pour vitrine: support murale en forme de L pour vitrine individuelle. Support de pied pour vitrines individuelles ou doubles.



TIME

RELOJ MURAL
WALL CLOCK - HORLOGE MURALE



| REF | ∅ | HT |
|----------|----|----|
| RE/AC/26 | 26 | 4 |
| RE/AC/31 | 31 | 4 |
| RE/AC/38 | 38 | 4 |



RELOJ MURAL

ESP. Colección de relojes fabricados en plástico y metal de alta calidad. Disponibles en varios tamaños, colores y diferentes acabados. Ideales para oficinas, colectividades y ambientes comunes.

WALL CLOCK

ENG. High quality clock range made of metal and plastic. Available in various colours, sizes and finishes. Suitable for offices and public/private places.

HORLOGE MURALE

FRA. Collection d'horloges en plastique et métal de très bonne qualité. Disponibles en plusieurs couleurs, dimensions et finitions. Idéale pour le bureau, les parties communes et publiques.



TIME

RELOJ MURAL
WALL CLOCK - HORLOGE MURALE



| REF | ∅ | H |
|----------|----|-----|
| RE/ME/38 | 38 | 5,5 |
| RE/ME/60 | 60 | 5,5 |
| RE/ME/75 | 75 | 5,5 |

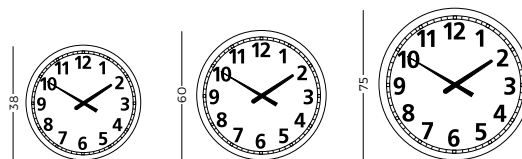

RELOJ MURAL

ESP. Colección de relojes fabricados en plástico y metal de alta calidad. Disponibles en varios tamaños, colores y diferentes acabados. Ideales para oficinas, colectividades y ambientes comunes.

WALL CLOCK

ENG. High quality clock range made of metal and plastic. Available in various colours, sizes and finishes. Suitable for offices and public/private places.

HORLOGE MURALE

FRA. Collection d'horloges en plastique et métal de très bonne qualité. Disponibles en plusieurs couleurs, dimensions et finitions. Idéale pour le bureau, les parties communes et publiques.

LIGHT

LÁMPARA DE SOBREMESA
TAMBLE LAMP - LAMPE DE BUREAU



| REF | L | H | LM. | LAMP. | COLORES |
|----------------|-------------------|----------|--------|-----------------|-----------------|
| LAS/106 | 15,7-40 x 13,7-35 | 5,3-13,5 | 550 lm | 6W LED - 4000K | /BL - /NG |
| LAS/107 | 49 x 16 | 34 | 250 lm | 11W LED - 2700K | /BL - /NG - /GR |

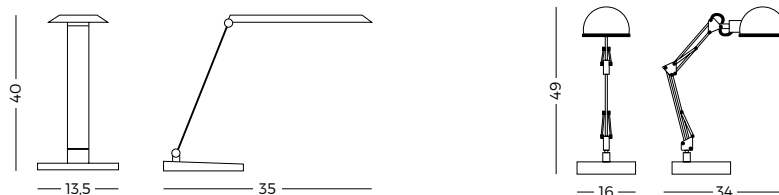

LÁMPARA DE SOBREMESA

ESP. Colección de lámparas de sobremesa de diseño y de alta calidad. Distintas referencias disponibles para diferentes espacios y proyectos. Lámparas LED y bombillas de bajo consumo. Recomendable tanto para oficina y contract como para el hogar.

DESK LAMP

ENG. Collection of high quality designer table lamps. Different models available depending on use. LED lamps with energy saving bulbs. Recommended for office, contract as well as home use.

LAMPE DE BUREAU

FRA. Collection de lampes de table design de grande qualité. Plusieurs références disponibles pour différents espaces et projets. Lampes LED et ampoule basse consommation. Recommandées tant pour le bureau et le « contract » que pour la maison.

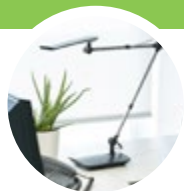
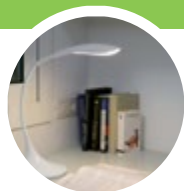

LIGHT

LÁMPARA DE SOBREMESA
TAMBLE LAMP - LAMPE DE BUREAU



COLOR



/NG /BL

REF

LAS/105
LAS/109

└─┘
15,5-34 x 12,5
59 - 20-70



10,5
15

LM.

800 lm
390 lm

LAMP.

10W LED - 4000K
5W LED - 3000K

COLORES

/BL - /NG
/NG

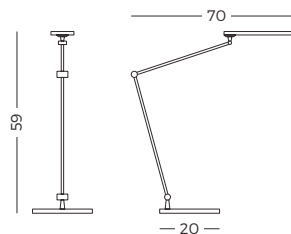
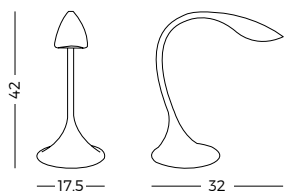

LÁMPARA DE SOBREMESA

ESP. Colección de lámparas de sobremesa de diseño y de alta calidad. Distintas referencias disponibles para diferentes espacios y proyectos. Lámparas LED y bombillas de bajo consumo. Recomendable tanto para oficina y contract como para el hogar.

DESK LAMP

ENG. Collection of high quality designer table lamps. Different models available depending on use. LED lamps with energy saving bulbs. Recommended for office, contract as well as home use.

LAMPE DE BUREAU

FRA. Collection de lampes de table design de grande qualité. Plusieurs références disponibles pour différents espaces et projets. Lampes LED et ampoule basse consommation. Recommandées tant pour le bureau et le « contract » que pour la maison.

ROTULPLAN

SISTEMAS DE ROTULACIÓN
SIGN SYSTEMS
SYSTÈMES DE SIGNALÉTIQUE



Locker Rooms



Toilets



Gymnasium

Fitness Center

2nd Floor

788

PICTOGRAMAS
 PICTOGRAM - PICTOGRAMME

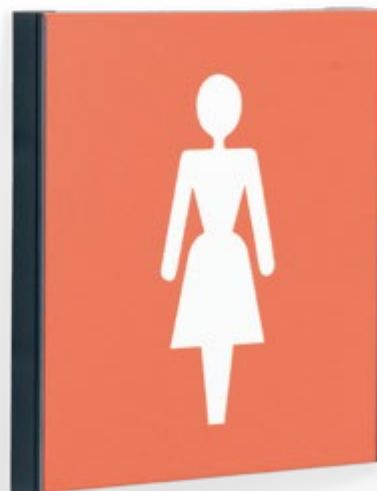

REF **DESC.**
788/M Mural
788/P Pictograma

COLOR

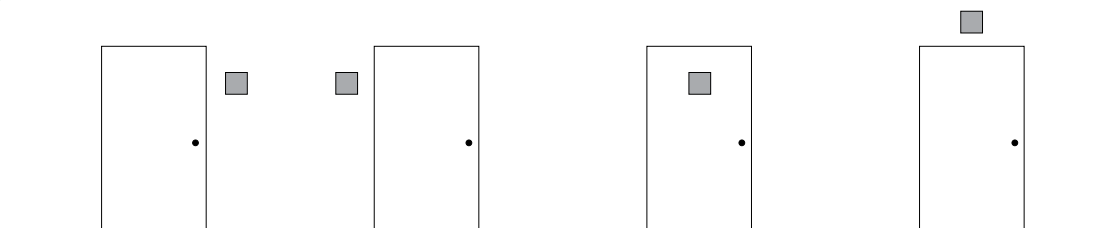
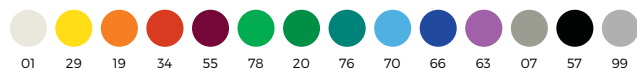

PICTOGRAMAS

ESP. Pictograma mural con silueta de vinilo en color blanco o negro, fabricado con perfil de aluminio lacado disponible en 14 colores standard y 4 tamaños distintos 12 x 12, 16 x 16, 12 x 24 y 16 x 32 cm. Las fijaciones laterales son metálicas pintadas en negro.

PICTOGRAM

ENG. Aluminium wall pictogram with white or black pictures and 14 different colour backdrops. Available in 4 sizes 12 x 12, 16 x 16, 12 x 24 and 16 x 32 cm. End caps are painted in black. Fixed to the wall through screws and optionally through double face adhesive.

PICTOGRAMME

FRA. Pictogramme mural sur profil en aluminium laqué avec marquage en vinyle blanc ou noir. Disponible en 4 formats 12 x 12, 16 x 16, 12 x 24 et 16 x 32 cm. et plaques en 14 couleurs standard. Les fixations latérales sont métalliques coloris noir. Option adhesif.



RÓTULO MURAL

| REF | L | H |
|-----------------|---------|-----|
| 788/M/12 | 12 x 12 | 0,9 |
| 788/M/16 | 16 x 16 | 0,9 |
| 788/M/24 | 12 x 24 | 0,9 |
| 788/M/32 | 16 x 32 | 0,9 |



RÓTULO MURAL

| REF | L | H |
|-----------------|---------|-----|
| 788/P/12 | 12 x 12 | 0,9 |
| 788/P/16 | 16 x 16 | 0,9 |
| 788/P/24 | 12 x 24 | 0,9 |
| 788/P/32 | 16 x 32 | 0,9 |

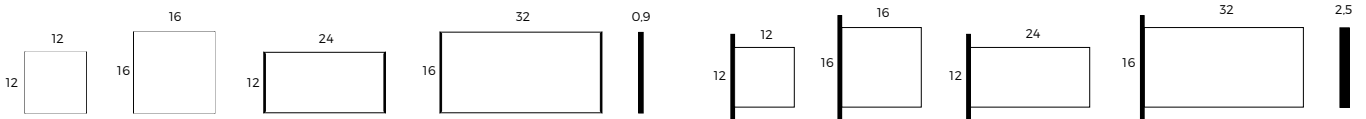

PICTOGRAMAS

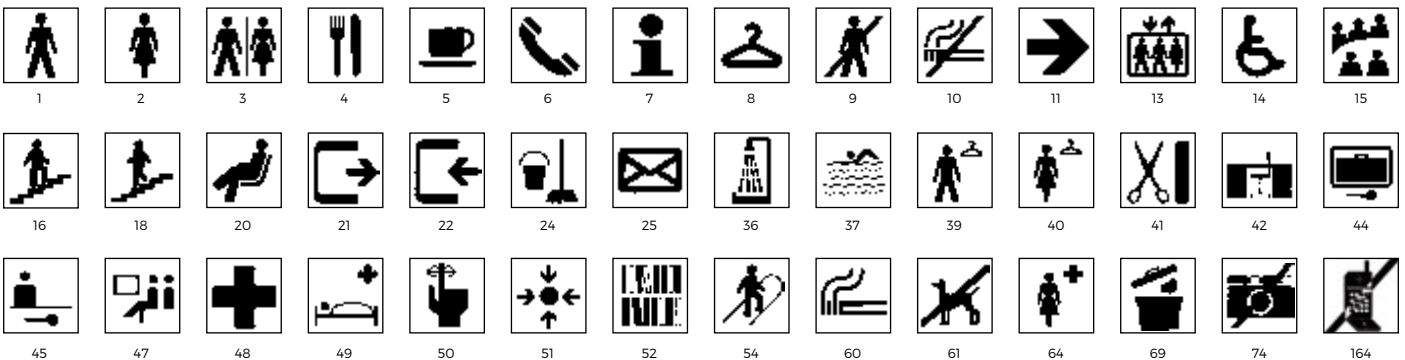

- 1. Aseos caballeros - Men toilet
- 2. Aseos señora - Women toilet
- 3. Aseos - Toilets-restroom
- 4. Restaurante - Restaurant
- 5. Cafetería - Coffee shop
- 6. Teléfono - Téléphone
- 7. Información - Information
- 8. Guardarropa - Cloakroom
- 9. No pasar - Do not cross

- 10. No fumar - No smoking
- 11. Flecha - Arrow
- 13. Ascensor - Lift
- 14. Diversidad funcional - Functional diversity
- 15. Sala de reuniones - Mtg. room
- 16. Subida escaleras - Up stairs
- 18. Bajada escaleras - Down stairs
- 20. Sala espera - Waiting room

- 21. Salida - Way out
- 22. Entrada - Way in
- 24. Limpieza - Cleaning room
- 25. Correos - Post office
- 36. Ducha - Shower
- 37. Piscina - Swimming pool
- 39. Vest. masc. - Men room
- 40. Vest. fem. - Women change room

- 41. Peluquería - Hairdresser
- 42. Oficina - Office
- 44. Consigna - Lockers
- 45. Recepción - Reception
- 47. Sala TV - TV room
- 48. Servicios médicos - Medical facilities
- 49. Hospital - Hospital
- 50. Silencio - Silence

- 51. Pto. de encuentro - Mtg. point
- 52. Biblioteca - Library
- 54. Escaleras - Escalator
- 60. Fumadores - Smoking room
- 61. Animales no - No animals entry
- 64. Enfermería - Infirmary
- 69. Basuras no - Rubbish bin
- 74. Fotos no - No cameras
- 164. Móviles no - No mobile phones

789/M

RÓTULOS MURALES
WALL SIGNS - SIGNALÉTIQUE MURALE

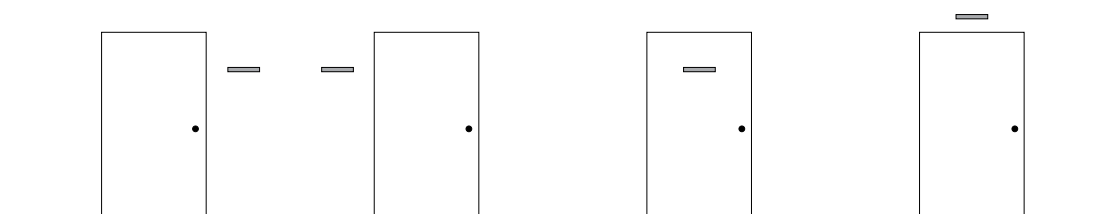
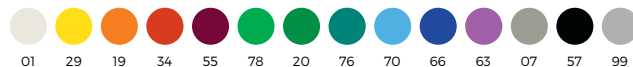
COLOR

RÓTULOS MURALES

ESP. Rótulo mural margen puerta de aluminio lacado, de texto fijo en vinilo de color blanco o negro. Disponible en 5 medidas de altura, 4, 8, 12 y 16 cm. y 14 colores standard. Se aplican sobre la pared mediante tornillos u opcionalmente con adhesivo doble cara.

WALL SIGNS

ENG. Aluminium wall signs for door frames with white or black letters and 14 different coloured backdrops. Available in 5 distinct sizes with heights of 4, 8, 12 and 16 cm. respectively. Mount any wall sign with screws or adhesives.

SIGNALÉTIQUE MURALE

FRA. Signalétique murale sur profil en aluminium laqué avec marquage en vinyle blanc ou noir. Disponible en 5 formats 4, 8, 12, et 16 cm. de haut et 14 coloris standard. Fixation par vis sous la plaque ou optionnellement par adhésif double face.



Información

Planta

RÓTULOS - 4 CM

| REF | L | TEXT | ABC |
|------------|--------|------|-------|
| 789/4/12/M | 4 x 12 | 2 | 8/10 |
| 789/4/24/M | 4 x 24 | 2 | 12/14 |
| 789/4/32/M | 4 x 32 | 2 | 18/20 |
| 789/4/48/M | 4 x 48 | 2 | 24/26 |
| 789/4/64/M | 4 x 64 | 2 | 28/30 |



RÓTULOS - 6 CM - 8 CM

| REF | L | TEXT | ABC |
|------------|--------|------|-------|
| 789/6/24/M | 6 x 24 | 2,6 | 8/10 |
| 789/6/32/M | 6 x 32 | 2,6 | 12/14 |
| 789/6/48/M | 6 x 48 | 2,6 | 18/20 |
| 789/6/64/M | 6 x 64 | 2,6 | 24/26 |
| 789/8/24/M | 8 x 24 | 3,2 | 8/10 |
| 789/8/32/M | 8 x 32 | 3,2 | 12/14 |
| 789/8/48/M | 8 x 48 | 3,2 | 18/20 |
| 789/8/64/M | 8 x 64 | 3,2 | 24/26 |



RÓTULOS - 12 CM - 16 CM

| REF | L | TEXT | ABC |
|-------------|---------|------|-------|
| 789/12/32/M | 12 x 32 | 4,8 | 8/10 |
| 789/12/48/M | 12 x 48 | 4,8 | 12/14 |
| 789/12/64/M | 12 x 64 | 4,8 | 18/20 |
| 789/12/96/M | 12 x 96 | 4,8 | 24/26 |
| 789/16/24/M | 16 x 32 | 6,4 | 6/8 |
| 789/16/32/M | 16 x 48 | 6,4 | 8/10 |
| 789/16/48/M | 16 x 64 | 6,4 | 12/14 |
| 789/16/64/M | 16 x 96 | 6,4 | 18/20 |



TEXTOS - 2ª LINEA

| REF | L |
|-------|----|
| TA/24 | 24 |
| TA/32 | 32 |
| TA/48 | 48 |
| TA/64 | 64 |
| TA/96 | 96 |

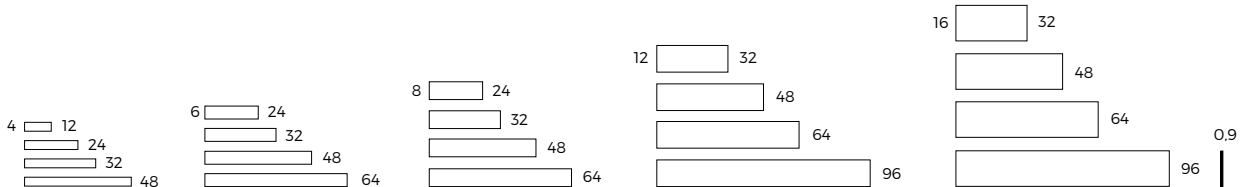

PICTOGRAMAS

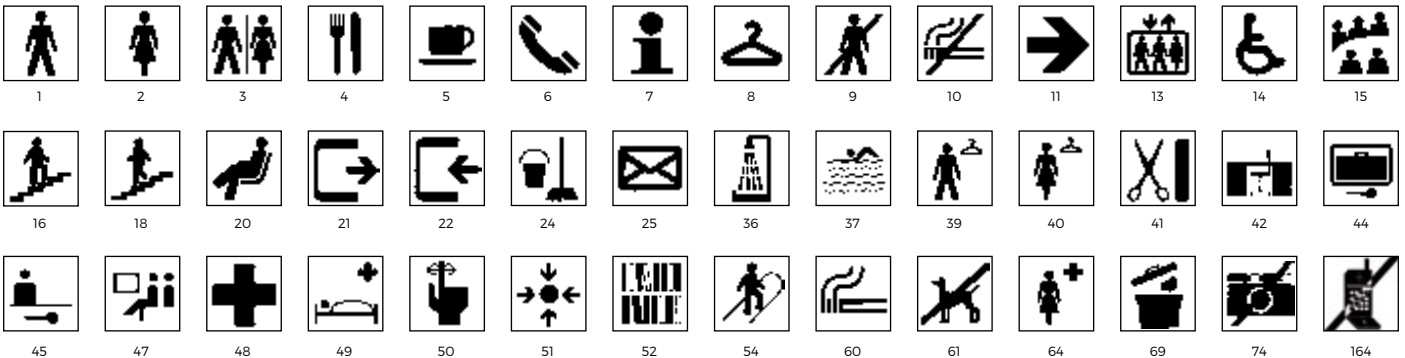

- 1. Aseos caballeros - Men toilet
- 2. Aseos señora - Women toilet
- 3. Aseos - Toilets - restroom
- 4. Restaurante - Restaurant
- 5. Cafetería - Coffee shop
- 6. Teléfono - Telephone
- 7. Información - Information
- 8. Guardarropa - Cloakroom
- 9. No pasar - Do not cross

- 10. No fumar - No smoking
- 11. Flecha - Arrow
- 13. Ascensor - Lift
- 14. Diversidad funcional - Functional diversity
- 15. Sala de reuniones - Mtg. room
- 16. Subida escaleras - Up stairs
- 18. Bajada escaleras - Down stairs
- 20. Sala espera - Waiting room

- 21. Salida - Way out
- 22. Entrada - Way in
- 24. Limpieza - Cleaning room
- 25. Correos - Post office
- 36. Ducha - Shower
- 37. Piscina - Swimming pool
- 39. Vest. masc. - Men room
- 40. Vest. fem. - Women change room

- 41. Peluquería - Hairdresser
- 42. Oficina - Office
- 44. Consigna - Lockers
- 45. Recepción - Reception
- 47. Sala TV - TV room
- 48. Servicios médicos - Medical facilities
- 49. Hospital - Hospital
- 50. Silencio - Silence

- 51. Pto. de encuentro - Mtg. point
- 52. Biblioteca - Library
- 54. Escaleras - Escalator
- 60. Fumadores - Smocking room
- 61. Animales no - No animals entry
- 64. Enfermería - Infirmary
- 69. Basuras no - Rubbish bin
- 74. Fotos no - No cameras
- 164. Móviles no - No mobile phones

789/P

RÓTULO PROYECTADO
FLAG SIGNS - SIGNALÉTIQUE EN DRAPEAU



COLOR

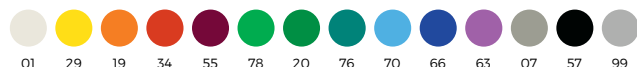

RÓTULO MURAL

| REF | L | H |
|-------------|---------|-----|
| 789/8/24/P | 8 x 24 | 2,5 |
| 789/8/32/P | 8 x 32 | 2,5 |
| 789/8/48/P | 8 x 48 | 2,5 |
| 789/12/24/P | 12 x 24 | 2,5 |
| 789/12/32/P | 12 x 32 | 2,5 |
| 789/12/48/P | 12 x 48 | 2,5 |
| 789/16/24/P | 16 x 24 | 2,5 |
| 789/16/32/P | 16 x 32 | 2,5 |
| 789/16/48/P | 16 x 48 | 2,5 |

SUBRAYADO

| REF | L | H |
|-----------|--------|-----|
| LS/2/24/P | 2 x 24 | 2,5 |
| LS/2/32/P | 2 x 32 | 2,5 |
| LS/2/48/P | 2 x 48 | 2,5 |

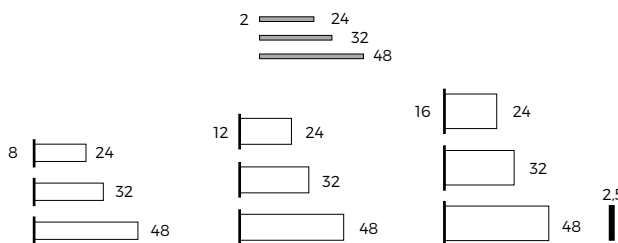

RÓTULO PROYECTADO

ESP. Rótulo proyectado doble cara de aluminio lacado, de texto fijo en vinilo de color blanco o negro. Disponible en 3 medidas de altura, 8, 12 y 16 cm. y de longitud 24, 32 y 48 cm. Se aplican sobre la pared mediante tornillos.

FLAG SIGNS

ENG. Aluminium double sided flag wall signs with white or black letters. Available in 3 distinct sizes with heights of 8, 12 and 16 cm. and lengths of 24, 32 and 48 cm. respectively. Mount any projected wall sign with screws.

SIGNALÉTIQUE EN DRAPEAU

FRA. Signalétique en drapeau sur profil en aluminium laqué avec marquage en vinyle blanc ou noir. Disponible en 3 formats 8, 12 et 16 cm. de haut. et 24, 32 et 48 cm. de longueurs. Fixation par vis sur la plaque.



789/S

RÓTULO SUSPENDIDO
SUSPENDED SIGNS - SIGNALÉTIQUE SUSPENDUE

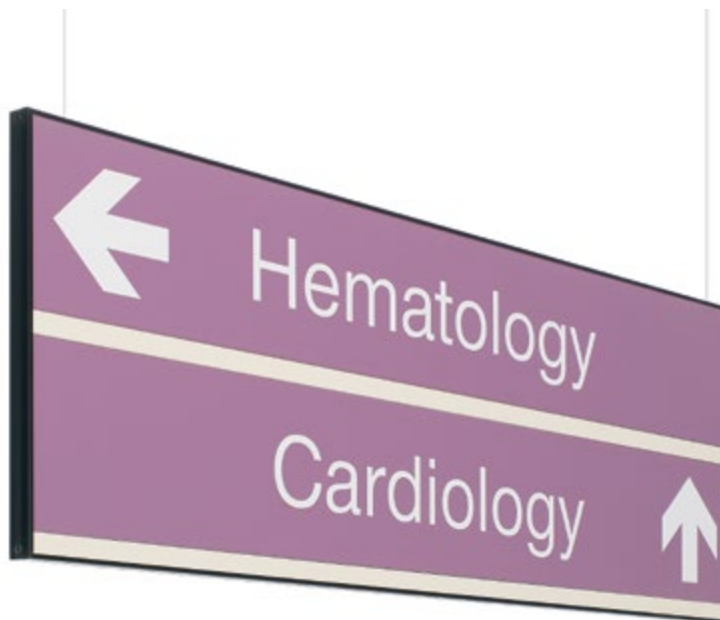

COLOR

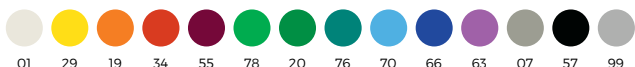

SUBRAYADO

| REF | L | H |
|-----------|--------|-----|
| LS/2/24/P | 2 x 24 | 2,5 |
| LS/2/32/P | 2 x 32 | 2,5 |
| LS/2/48/P | 2 x 48 | 2,5 |

RÓTULO SUSPENDIDO

| REF | L | H |
|-------------|---------|-----|
| 789/8/48/S | 8 x 48 | 2,5 |
| 789/8/64/S | 8 x 64 | 2,5 |
| 789/8/96/S | 8 x 96 | 2,5 |
| 789/12/48/S | 12 x 48 | 2,5 |
| 789/12/64/S | 12 x 64 | 2,5 |
| 789/12/96/S | 12 x 96 | 2,5 |
| 789/16/48/S | 16 x 48 | 2,5 |
| 789/16/64/S | 16 x 64 | 2,5 |
| 789/16/96/S | 16 x 96 | 2,5 |

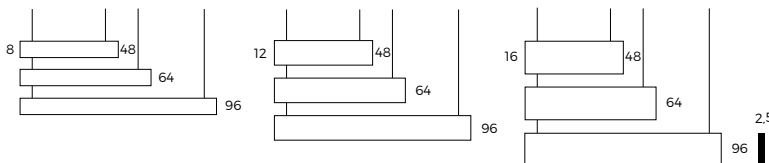

RÓTULO SUSPENDIDO

ESP. Rótulo suspendido doble cara de aluminio lacado, de texto fijo en vinilo de color blanco o negro. Disponible en 3 medidas de altura, 8, 12 y 16 cm. Se suspenden del techo mediante cable de metal (incluido). Estas señales se colocan en pasillos y accesos.

SUSPENDED SIGNS

ENG. Aluminium suspended signs with white or black letters and 14 different colored backdrops. Available in 3 distinct sizes with heights of 8, 12 and 16 cm. Suspend sign with included metallic string.

SIGNALÉTIQUE SUSPENDU

FRA. Signalétique suspendue sur profil en aluminium laqué avec marquage en vinyle blanc ou noir. Disponible en 3 formats 8, 12, et 16 cm. de hauteur. Suspendus au plafond par un câble de métallique (inclus).

790/D

DIRECTORIO MURAL
DIRECTIONAL SIGNS - MULTI-PLAQUES



COLOR

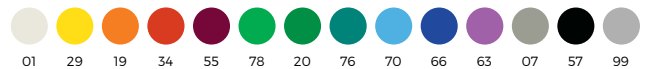

| | |
|----------------|--|
| 2 | |
| Marketing | |
| Administration | |
| 1 | |
| R+d | |
| Laboratory | |
| 0 | |
| Reception | |

| | |
|----------------|---|
| GANT HOTEL | |
| 1. Information | → |
| 2. Rooms | ↑ |
| 3. Pool | ← |
| 4. Gymnasium | ↓ |
| 1 | 2 |
| 3 | 4 |

| | |
|-----------------|---|
| High School | |
| Classroom 1-10 | → |
| Classroom 11-20 | → |
| Classroom 21-30 | ↑ |
| Classroom 31-40 | ↑ |
| Information | → |
| Gymnasium | ← |
| Toilets | ↑ |

| | |
|----------------|---|
| SPORT | |
| Gymnasium | → |
| Cafeteria | → |
| Natatorium | ↑ |
| Toilets | ↑ |
| Fitness Center | → |
| Tennis Courts | ← |

| | |
|---|------------------|
| 3 | UCI |
| | Administration |
| 2 | Oncology |
| | Endoscopy |
| 1 | Medical Imaging |
| | Volunter Service |
| 0 | Main Entrance |
| | Administration |
| | Waiting Room |

DIRECTORIOS MURALES

ESP. Directorio formado por laminas de aluminio lacado, de texto fijo en vinilo de color blanco o negro. Disponible en 7 medidas de altura, 1, 2, 4, 6, 8, 12 y 16 cm. Disponible en 14 colores.

DIRECTIONAL SIGNS

ENG. Lacquered aluminium mini directories with white or black letters and 14 different colour backdrops. Available in 7 distinct sizes with heights of 1, 2, 4, 6, 8, 12 and 16 cm.

MULTI-PLAQUES

FRA. Directoire multi plaques sur profil en aluminium laqué avec lettres blanches ou noires et 14 coloris standard. Disponible en 7 formats 1, 2, 4, 6, 8, 12 et 16 cm. de haut.

PLANTA 2

 Información 

RÓTULOS - 2 CM - 4 CM

| REF | L | TEXT | ABC |
|------------|--------|------|-------|
| 790/2/24/D | 2 x 24 | - | - |
| 790/2/32/D | 2 x 32 | - | - |
| 790/2/48/D | 2 x 48 | - | - |
| 790/2/64/D | 2 x 64 | - | - |
| 790/2/96/D | 2 x 96 | - | - |
| 790/4/24/D | 4 x 24 | 2 | 12/20 |
| 790/4/32/D | 4 x 32 | 2 | 18/24 |
| 790/4/48/D | 4 x 48 | 2 | 24/26 |
| 790/4/64/D | 4 x 64 | 2 | 36/38 |
| 790/4/96/D | 4 x 96 | 2 | 60/62 |



RÓTULOS - 6 CM - 8 CM

| REF | L | TEXT | ABC |
|------------|--------|------|-------|
| 790/6/24/D | 6 x 24 | 2 | 10/18 |
| 790/6/32/D | 6 x 32 | 2 | 14/16 |
| 790/6/48/D | 6 x 48 | 2 | 20/24 |
| 790/6/64/D | 6 x 64 | 2 | 30/36 |
| 790/6/96/D | 6 x 96 | 2 | 40/48 |
| 790/8/24/D | 8 x 24 | 3,2 | 8/10 |
| 790/8/32/D | 8 x 32 | 3,2 | 12/14 |
| 790/8/48/D | 8 x 48 | 3,2 | 16/18 |
| 790/8/64/D | 8 x 64 | 3,2 | 24/26 |
| 790/8/96/D | 8 x 96 | 3,2 | 36/38 |



RÓTULOS - 12 CM - 16 CM

| REF | L | TEXT | ABC |
|-------------|---------|------|-------|
| 790/12/24/D | 12 x 24 | 4,8 | 6/8 |
| 790/12/32/D | 12 x 32 | 4,8 | 8/10 |
| 790/12/48/D | 12 x 48 | 4,8 | 12/14 |
| 790/12/64/D | 12 x 64 | 4,8 | 18/20 |
| 790/12/96/D | 12 x 96 | 4,8 | 24/26 |
| 790/16/24/D | 16 x 24 | 6,4 | 4/6 |
| 790/16/32/D | 16 x 32 | 6,4 | 6/8 |
| 790/16/48/D | 16 x 48 | 6,4 | 8/10 |
| 790/16/64/D | 16 x 64 | 6,4 | 12/24 |
| 790/16/96/D | 16 x 96 | 6,4 | 18/20 |

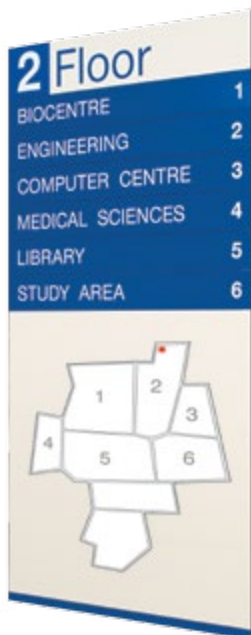
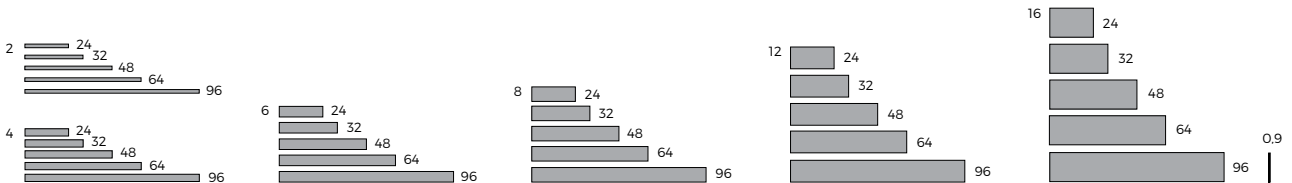

PLANOS

| REF | L | TEXT |
|-----------|---------|------|
| 790/PD/24 | 24 x 24 | 0,9 |
| 790/PD/32 | 32 x 32 | 0,9 |
| 790/PD/48 | 48 x 48 | 0,9 |
| 790/PD/64 | 64 x 64 | 0,9 |
| 790/PD/96 | 96 x 96 | 0,9 |



TEXTOS - 2ª LINEA

| REF | L |
|-------|----|
| TA/24 | 24 |
| TA/32 | 32 |
| TA/48 | 48 |
| TA/64 | 64 |
| TA/96 | 96 |

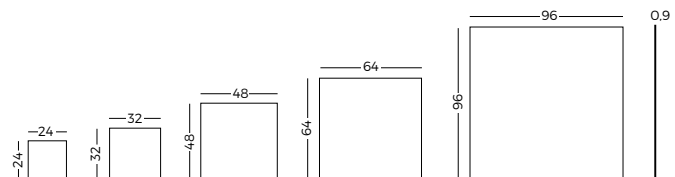

793/M

RÓTULO CURVO
CURVED SIGNS - SIGNALÉTIQUE EN COURBÉ



Los rótulos se suministran sin papel.
Signs supplied without paper.
Signalétique sans papier.

| REF | L | H | ? |
|-----------------|---------|-----|-----------|
| 793/M/12 | 12 x 12 | 1 | 11,5 x 12 |
| 793/M/15 | 15 x 15 | 1,2 | 14,5 x 15 |
| 793/M/21 | 21 x 21 | 1,4 | 20,5 x 21 |
| 793/M/30 | 30 x 30 | 1,8 | 29,5 x 30 |
| 793/M/40 | 40 x 40 | 2 | 39,5 x 40 |

| REF | L | H | ? |
|-----------------|-----------|-----|-------------|
| 793/M/50 | 50 x 50 | 2,5 | 49,5 x 50 |
| 793/M/60 | 60 x 60 | 3 | 59,5 x 60 |
| 793/M/A5 | 21 x 15 | 1,2 | 20,5 x 15 |
| 793/M/A4 | 29,7 x 21 | 1,4 | 29,2 x 21 |
| 793/M/A3 | 42 x 29,7 | 1,8 | 41,5 x 29,7 |

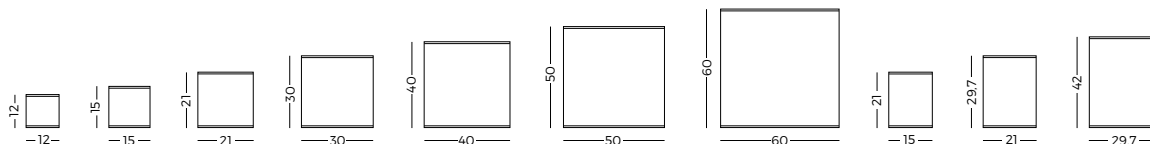

PICTOGRAMA Y DIRECTORIO CURVO

ESP. Rótulos de perfil curvo para pictogramas murales. Está fabricado con perfil de aluminio anodinado en color plata mate. El soporte permite la incorporación del papel pictograma o texto). Mediante una ventosa especial se puede levantar el plástico protector.

CURVED PICTOGRAMS AND DIRECTORY

ENG. Curved profile wall pictos made with silver anodized aluminium frame. The transparent sleeve allows you to add paper with pictograms or text. With suction cup pull off transparent sleeve to change text. Place on the wall with screws or optionally adhesive.

PICTOGRAMMES ET PLAQUES COURBÉ

FRA. Profil mural en aluminium anodisé convexe pour signalétique ou pictogrammes. L'incorporation de l'information papier (pictogramme ou texte) est facile. Grâce à une ventouse on enlève le plastique transparent qui protège le support et on insère le texte.



793/P

PICTOGRAMA PROYECTADO CURVO
 CURVED DOUBLE SIDED FLAG PICTOGRAM - PICTOGRAMME EN DRAPEAU COURBÉ



Los rótulos se suministran sin papel.
 Signs supplied without paper.
 Signalétique sans papier.

| REF | L | H | ? |
|-----------------|---------|-----|-----------|
| 793/P/15 | 15 x 15 | 2,4 | 14,5 x 15 |
| 793/P/21 | 21 x 21 | 2,8 | 20,5 x 21 |
| 793/P/30 | 30 x 30 | 3,6 | 29,5 x 30 |

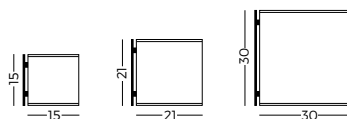

PICTOGRAMA PROYECTADO CURVO

ESP. Rótulo de perfil curvo para pictogramas proyectados (doble cara). Está fabricado con perfil de aluminio anodizado en color plata mate. El soporte permite la incorporación del papel (pictograma o texto). Mediante una ventosa se puede levantar el plástico protector.

CURVED FLAG PICTOGRAM

ENG. Curved profile double sided flag pictos with for wall pictograms made with silver anodized aluminium frame. The support allows you to add paper with pictograms or text. With suction cup pull off transparent sleeve. Place on the wall with screws.

PICTOGRAMME EN DRAPEAU COURBÉ

FRA. Profil mural en aluminium anodisé convexe pour signalétique ou pictogrammes. L'incorporation de l'information papier (picto ou texte) est facile. Grâce à une ventouse on enlève le plastique transparent qui protège le support et on insère le texte.

799/M

RÓTULO MURAL CURVO
CURVED PROFILE SIGN - SIGNALÉTIQUE COURBE



Los rótulos se suministran sin papel.
Signs supplied without paper.
Signalétique sans papier.

| REF | DESC. |
|-------|------------|
| 799/M | Mural |
| 799/P | Pictograma |

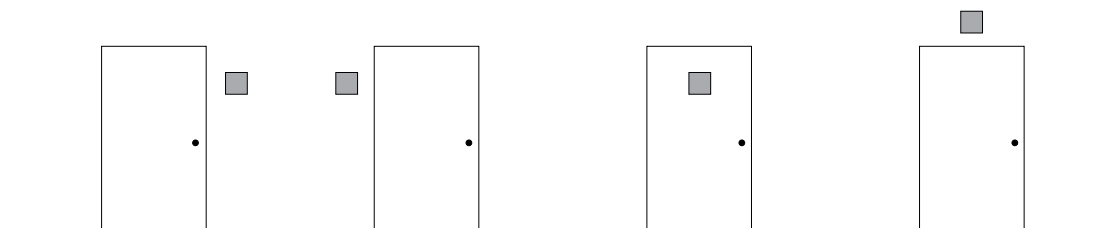

RÓTULO MURAL PERFIL CURVO

ESP. Rótulo mural de perfil curvo. Está fabricado con perfil de aluminio anodizado en color plata mate. El soporte permite la incorporación del papel (pictograma o texto). Mediante una ventosa especial se puede levantar frontalmente el plástico transparente que lo protege.

CURVED PROFILE SIGN

ENG. Wall curved profile sign made with silver anodized aluminium frame. The transparent sleeve allows you to add paper with pictograms or text. With a suction cup pull off the transparent sleeve to change the text. Placed on the wall with screws or with adhesive.

SIGNALÉTIQUE PROFIL COURBE

FRA. Profil mural en aluminium anodisé convexe pour signalétique ou pictogrammes. L'incorporation de l'information papier (picto ou texte) est facile. Grâce à une ventouse on enlève le plastique transparent qui protège le support et on insère le texte. Option adhesifs.



RÓTULOS MURAL

| REF | L | H |
|-------------|---------|-----|
| 799/4/12/M | 4 x 12 | 0,8 |
| 799/4/24/M | 4 x 24 | 0,8 |
| 799/4/32/M | 4 x 32 | 0,8 |
| 799/4/48/M | 4 x 48 | 0,8 |
| 799/4/64/M | 4 x 64 | 0,8 |
| 799/6/12/M | 6 x 12 | 0,8 |
| 799/6/24/M | 6 x 24 | 0,8 |
| 799/6/32/M | 6 x 32 | 0,8 |
| 799/6/48/M | 6 x 48 | 0,8 |
| 799/6/64/M | 6 x 64 | 0,8 |
| 799/8/12/M | 8 x 12 | 1 |
| 799/8/24/M | 8 x 24 | 1 |
| 799/8/32/M | 8 x 32 | 1 |
| 799/8/48/M | 8 x 48 | 1 |
| 799/8/64/M | 8 x 64 | 1 |
| 799/12/24/M | 12 x 24 | 1 |
| 799/12/32/M | 12 x 32 | 1 |
| 799/12/48/M | 12 x 48 | 1 |
| 799/12/64/M | 12 x 64 | 1 |
| 799/12/72/M | 12 x 72 | 1 |
| 799/15/24/M | 15 x 24 | 1,2 |
| 799/15/32/M | 15 x 32 | 1,2 |
| 799/15/48/M | 15 x 48 | 1,2 |
| 799/15/64/M | 15 x 64 | 1,2 |
| 799/15/72/M | 15 x 72 | 1,2 |

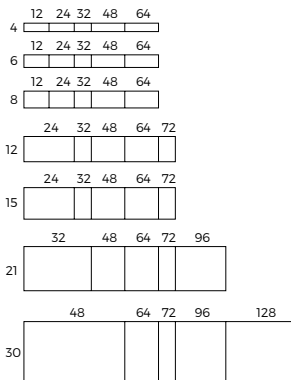

RÓTULOS - 6 CM - 8 CM

| REF | L | H |
|--------------|----------|-----|
| 799/21/32/M | 21 x 32 | 1,4 |
| 799/21/48/M | 21 x 48 | 1,4 |
| 799/21/64/M | 21 x 64 | 1,4 |
| 799/21/72/M | 21 x 72 | 1,4 |
| 799/21/96/M | 21 x 96 | 1,4 |
| 799/30/48/M | 30 x 48 | 1,8 |
| 799/30/64/M | 30 x 64 | 1,8 |
| 799/30/72/M | 30 x 72 | 1,8 |
| 799/30/96/M | 30 x 96 | 1,8 |
| 799/30/128/M | 30 x 128 | 1,8 |
| 799/40/64/M | 40 x 64 | 2 |
| 799/40/72/M | 40 x 72 | 2 |
| 799/40/96/M | 40 x 96 | 2 |
| 799/40/128/M | 40 x 128 | 2 |
| 799/50/64/M | 50 x 64 | 2 |
| 799/50/72/M | 50 x 72 | 2 |
| 799/50/96/M | 50 x 96 | 2 |
| 799/50/128/M | 50 x 128 | 2 |
| 799/60/72/M | 60 x 72 | 2 |
| 799/60/96/M | 60 x 96 | 2 |
| 799/60/128/M | 60 x 128 | 2 |
| 799/60/144/M | 60 x 144 | 2 |

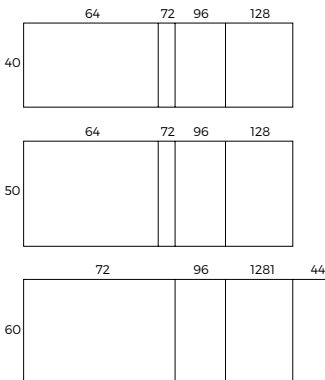

RÓTULOS - 6 CM - 8 CM

| REF | L | H |
|-------------|---------|-----|
| 799/15/24/P | 15 x 24 | 2,4 |
| 799/15/32/P | 15 x 32 | 2,4 |
| 799/15/48/P | 15 x 48 | 2,4 |
| 799/30/32/P | 30 x 32 | 3,6 |
| 799/30/48/P | 30 x 48 | 3,6 |

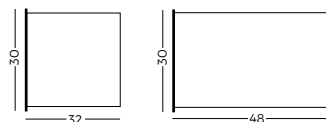
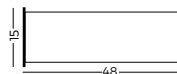
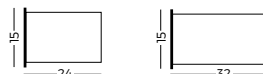

799/S

RÓTULO SUSPENDIDO CURVO
 SUSPENDED CURVED SIGNS - SIGNALÉTIQUE SUSPENDUÊ COURBÉ

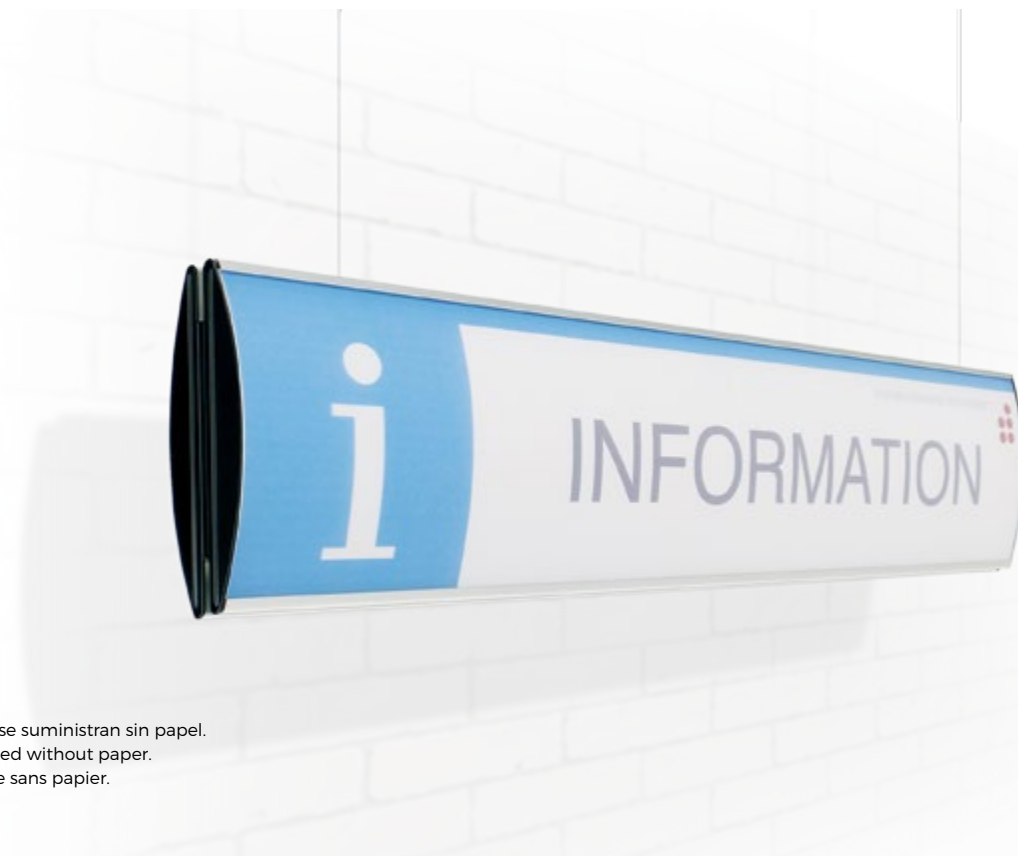

Los rótulos se suministran sin papel.
 Signs supplied without paper.
 Signalétique sans papier.

| REF | L | H |
|--------------------|---------|-----|
| 799/8/48/S | 8 x 48 | 2 |
| 799/8/64/S | 8 x 64 | 2 |
| 799/8/96/S | 8 x 96 | 2 |
| 799/12/48/S | 12 x 48 | 2 |
| 799/12/64/S | 12 x 64 | 2 |
| 799/12/96/S | 12 x 96 | 2 |
| 799/15/48/S | 15 x 48 | 2,4 |
| 799/15/64/S | 15 x 64 | 2,4 |
| 799/15/96/S | 15 x 96 | 2,4 |

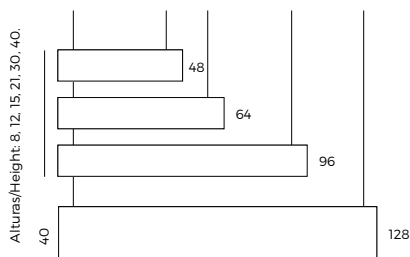

| REF | L | H |
|---------------------|----------|-----|
| 799/21/48/S | 21 x 48 | 2,8 |
| 799/21/64/S | 21 x 64 | 2,8 |
| 799/21/96/S | 21 x 96 | 2,8 |
| 799/30/48/S | 30 x 48 | 3,6 |
| 799/30/64/S | 30 x 64 | 3,6 |
| 799/30/96/S | 30 x 96 | 3,6 |
| 799/40/64/S | 40 x 64 | 4 |
| 799/40/96/S | 40 x 96 | 4 |
| 799/40/128/S | 40 x 128 | 4 |



PICTOGRAMA Y DIRECTORIO CURVO

ESP. Rótulo suspendido doble cara de perfil curvo. Está fabricado con perfil de aluminio anodizado en color plata mate. El soporte permite la incorporación del papel (pictograma o texto). Mediante una ventosa especial se puede levantar el plástico protector.

SUSPENDED CURVED PROFILE SIGNS

ENG. Wall curved profile double side signs made with silver anodized aluminium frame. The transparent sleeve allows you to add paper with pictograms or text. With a suction cup pull off the transparent sleeve to change the text.

SIGNALÉTIQUE SUSPENDU COURBÉ

FRA. Profil suspendu double face en aluminium anodisé convexe pour signalétique ou pictogrammes. L'incorporation de l'information papier (picto ou texte) est facile. Grâce à une ventouse on enlève le plastique transparent qui protège le support et on insère le texte.





799/SB

RÓTULO SOBREMESA CURVO
DESK CURVED SIGNS - SIGNALÉTIQUE À POSER COURBÉ



Los rótulos se suministran sin papel.
Signs supplied without paper.
Signalétique sans papier.

| REF | L | H |
|---------------------|---------|-----|
| 799/6/24/SB | 6 x 24 | 0,8 |
| 799/6/32/SB | 6 x 32 | 0,8 |
| 799/8/24/SB | 8 x 24 | 1 |
| 799/8/32/SB | 8 x 32 | 1 |
| 799/12/12/SB | 12 x 12 | 1 |

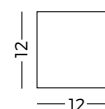
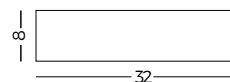
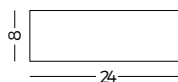
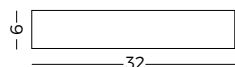
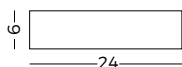

RÓTULO SOBREMESA PERFIL CURVO

ESP. Rótulo de sobremesa perfil curvo. Está fabricado con perfil de aluminio anodizado en color plata mate. El soporte permite la incorporación del papel (pictograma o texto) Mediante una ventosa especial se puede levantar el plástico protector.

DESK CURVED PROFILE SIGNS

ENG. Signs with curved profile desks wall are made with silver anodized aluminium frame. The transparent sleeve allows you to add paper with pictograms or text. With a suction cup pull off the transparent sleeve to change the text.

SIGNALÉTIQUE À POSER PROFIL COURBÉ

FRA. Signalétique à poser, en aluminium anodisé convexe pour signalétique ou pictogrammes. L'incorporation de l'information papier (picto ou texte) est facile. Grâce à une ventouse on enlève le plastique transparent qui protège le support et on insère le texte.

799/M

DIRECTORIO PERFIL CURVO
CURVED PROFILE DIRECTORIES - MULTI-PLAQUES PROFIL COURBÉ



Los rótulos se suministran sin papel.
Signs supplied without paper.
Signalétique sans papier.

| REF | L | H |
|------------|--------|-----|
| 799/4/12/M | 4 x 12 | 0,8 |
| 799/4/24/M | 4 x 24 | 0,8 |
| 799/4/32/M | 4 x 32 | 0,8 |
| 799/4/48/M | 4 x 48 | 0,8 |
| 799/4/64/M | 4 x 64 | 0,8 |
| 799/6/12/M | 6 x 12 | 0,8 |
| 799/6/24/M | 6 x 24 | 0,8 |
| 799/6/32/M | 6 x 32 | 0,8 |
| 799/6/48/M | 6 x 48 | 0,8 |
| 799/6/64/M | 6 x 64 | 0,8 |

| REF | L | H |
|------------|--------|---|
| 799/8/12/M | 8 x 12 | 1 |
| 799/8/24/M | 8 x 24 | 1 |
| 799/8/32/M | 8 x 32 | 1 |
| 799/8/48/M | 8 x 48 | 1 |
| 799/8/64/M | 8 x 64 | 1 |
| 799/8/96/M | 8 x 96 | 1 |

| REF | L | H |
|-------------|---------|-----|
| 799/12/24/M | 12 x 24 | 1 |
| 799/12/32/M | 12 x 32 | 1 |
| 799/12/48/M | 12 x 48 | 1 |
| 799/12/64/M | 12 x 64 | 1 |
| 799/12/72/M | 12 x 72 | 1 |
| 799/15/24/M | 15 x 24 | 1,2 |
| 799/15/32/M | 15 x 32 | 1,2 |
| 799/15/48/M | 15 x 48 | 1,2 |
| 799/15/64/M | 15 x 64 | 1,2 |
| 799/15/72/M | 15 x 72 | 1,2 |

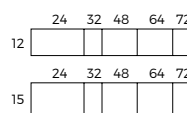
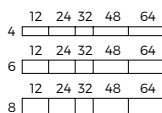

DIRECTORIOS PERFIL CURVO

ESP. Rótulo mural de perfil curvo. Está fabricado con perfil de aluminio anodizado en color plata mate. El soporte permite la incorporación del papel (pictograma o texto). Mediante una ventosa especial se puede levantar frontalmente el plástico transparente que lo protege.

CURVED PROFILE DIRECTORIES

ENG. Wall curved profile sign made with silver anodized aluminium frame. The transparent sleeve allows you to add paper with pictograms or text. With a suction cup pull off the transparent sleeve to change the text. Placed on the wall with screws or with adhesive.

MULTI-PLAQUES PROFIL COURBÉ

FRA. Profil mural en aluminium anodisé convexe pour signalétique ou pictogrammes. L'incorporation de l'information papier (pictogramme ou texte) est facile. Grâce à une ventouse on enlève le plastique transparent qui protège le support et on insère le texte.



799/T

TOTEM PERFIL CURVO
CURVED PROFILE TOTEM - TOTEM PROFIL COURBÉ



Los rótulos se suministran sin papel.
Signs supplied without paper.
Signalétique sans papier.

| REF | L |
|------------|----------|
| 799/T2/180 | 180 x 60 |
| 799/T2/200 | 200 x 60 |



| REF | L |
|------------|----------|
| 799/T3/180 | 180 x 60 |
| 799/T3/200 | 200 x 60 |
| 799/T3/220 | 220 x 60 |

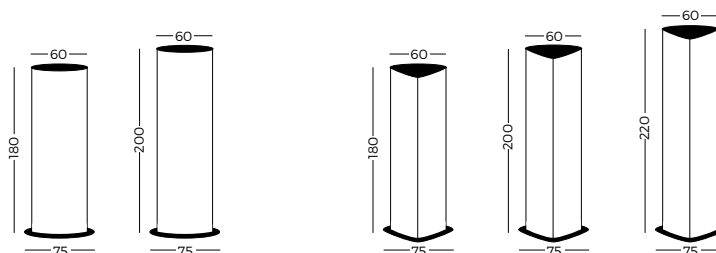

TOTEM PERFIL CURVO

ESP. Totems verticales doble o triple cara de perfil curvo. Están fabricados con perfil de aluminio anodizado en color plata mate. El soporte permite la incorporación del documento mediante una ventosa especial para levantar el plástico transparente que lo protege.

CURVED PROFILE TOTEM

ENG. Totem double or triple side made of anodized aluminium, which allow to switch texts and pictograms with a suction cup to pull off the transparent sleeve to change the information.

TOTEM PROFIL COURBÉ

FRA. Totems sur profil courbe en aluminium anodisé double et triple face. Le support permet l'incorporation de papier (pictos ou texte) grâce à une ventouse on enlève le plastique transparent qui protège le support et ainsi changer l'information.

GR/M

PICTOGRAMAS Y DIRECTORIOS "GRIP"
WALL SIGN "GRIP" - SIGNALÉTIQUE MURALE "GRIP"

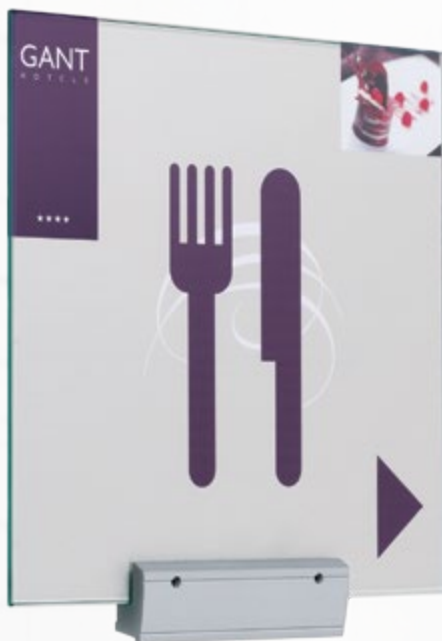

| REF | DESC. | L | H |
|---------|---------|---------|-----|
| GR/12/M | Panel | 12 x 12 | 1,6 |
| GR/16/M | Panel | 16 x 16 | 1,6 |
| GR/21/M | Panel | 21 x 21 | 1,6 |
| GR/A4/M | Panel | 30 x 21 | 1,6 |
| GR/A3/M | Panel | 42 x 30 | 1,6 |
| GR/A2/M | Panel | 60 x 42 | 1,6 |
| GR/10 | Soporte | 4 x 10 | 1,6 |
| GR/20 | Soporte | 4 x 20 | 1,6 |

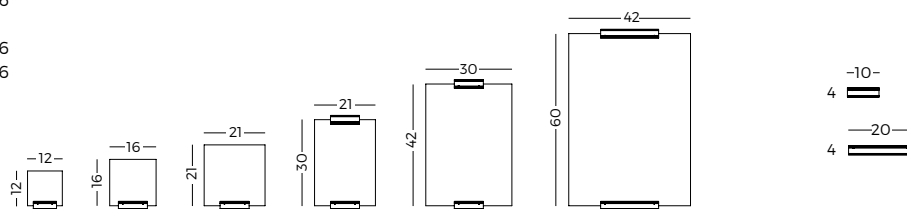

PICTOGRAMAS Y DIRECTORIOS "GRIP"

ESP. Sistema de señalización de interiores fabricado en aluminio y vidrio. La pinza "Grip" de aluminio disponible en diversos formatos sujeta el rótulo situado entre el cristal y la trasería metálica. Disponible en versión mural, sobremesa y con soporte.

WALL SIGN "GRIP"

ENG. Signing system for the inside in anodized aluminium and glass. The grip is available in various sizes. Wall, table or stand version. Delivered with one allen key. Picto and text not included.

SIGNALÉTIQUE MURALE "GRIP"

FRA. Système de signalisation d'intérieur en aluminium anodisé et verre. La pince est disponible en divers formats, version murale, sur table ou avec piétement. Livré avec une clé allen. Picto et texte non inclus.



GR/M

PICTOGRAMAS Y DIRECTORIOS "GRIP"
WALL SIGN "GRIP" - SIGNALÉTIQUE MURALE "GRIP"



| REF | DESC. | L | H |
|-------|---------|--------|-----|
| GR/10 | Soporte | 4 x 10 | 1,6 |
| GR/20 | Soporte | 4 x 20 | 1,6 |

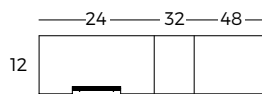
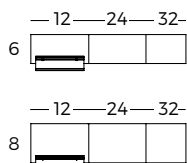

| REF | DESC. | L | H |
|------------|-------|---------|-----|
| GR/6/12/M | Panel | 6 x 12 | 1,6 |
| GR/6/24/M | Panel | 6 x 24 | 1,6 |
| GR/6/32/M | Panel | 6 x 32 | 1,6 |
| GR/8/12/M | Panel | 8 x 12 | 1,6 |
| GR/8/24/M | Panel | 8 x 24 | 1,6 |
| GR/8/32/M | Panel | 8 x 32 | 1,6 |
| GR/12/24/M | Panel | 12 x 24 | 1,6 |
| GR/12/32/M | Panel | 12 x 32 | 1,6 |
| GR/12/48/M | Panel | 12 x 48 | 1,6 |



PICTOGRAMAS Y DIRECTORIOS "GRIP"

ESP. Sistema de señalización de interiores fabricado en aluminio y vidrio. La pinza "Grip" de aluminio disponible en diversos formatos sujeta el rótulo situado entre el cristal y la trasera metálica. Disponible en versión mural, sobremesa y con soporte.

WALL SIGN "GRIP"

ENG. Signing system for the inside in anodized aluminium and glass. The grip is available in various sizes. Wall, table or stand version. Delivered with one allen key. Picto and text not included.

SIGNALÉTIQUE MURALE "GRIP"

FRA. Système de signalisation d'intérieur en aluminium anodisé et verre. La pince est disponible en divers formats, version murale, sur table ou avec piétement. Livré avec une clé allen. Picto et texte non inclus.

GR/SB

RÓTULOS DE SOBREMESA "GRIP"
SIGN FOR TABLE "GRIP" - SIGNALÉTIQUE SUR TABLE "GRIP"



| REF | L | H |
|------------|---------|-----|
| GR/6/12/SB | 6 x 12 | 4,5 |
| GR/8/24/SB | 8 x 24 | 4,5 |
| GR/16/SB | 16 x 16 | 4,5 |
| GR/A4/SB | 30 x 21 | 4,5 |

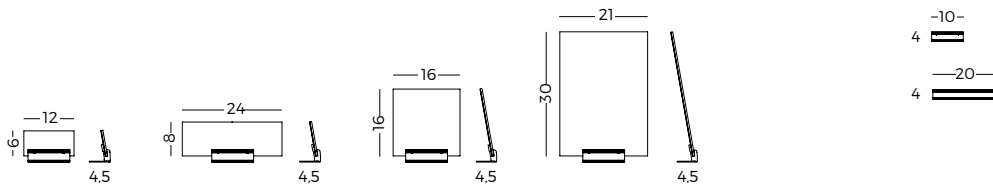

RÓTULOS DE SOBREMESA "GRIP"

ESP. Sistema de señalización de interiores fabricado en aluminio y vidrio. La pinza "Grip" de aluminio disponible en diversos formatos sujeta el rótulo situado entre el cristal y la traseira metálica. Disponible en versión mural, sobremesa y con soporte.

SIGN FOR TABLE "GRIP"

ENG. Signing system for the inside in anodized aluminium and glass. The grip is available in various sizes. Wall, table or stand version. Delivered with one allen key. Picto and text not included

SIGNALÉTIQUE SUR TABLE "GRIP"

FRA. Système de signalisation d'intérieur en aluminium anodisé et verre. La pince est disponible en divers formats, version murale, sur table ou avec piétement. Livré avec une clé allen. Picto et texte non inclus.



GR/P

RÓTULOS "GRIP" CON SOPORTE

TAGLINE "GRIP" WITH SUPPORT - SIGNALÉTIQUE "GRIP" SUR PIÉTEMENT

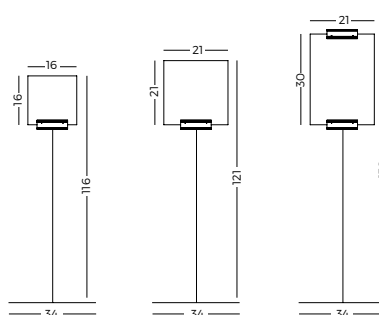

| REF | L | H |
|---------|---------|-----|
| GR/16/P | 16 x 16 | 116 |
| GR/21/P | 21 x 21 | 121 |
| GR/A4/P | 30 x 21 | 130 |



RÓTULOS "GRIP" CON SOPORTE

ESP. Sistema de señalización de interiores fabricado en aluminio y vidrio. La pinza "Grip" de aluminio disponible en diversos formatos sujeta el rótulo situado entre el cristal y la trasera metálica. Disponible en versión mural, sobremesa y con soporte.

TAGLINE "GRIP" WITH SUPPORT

ENG. Signing system for the inside in anodized aluminium and glass. The grip is available in various sizes. Wall, table or stand version. Delivered with one allen key. Picto and text not included.

SIGNALÉTIQUE "GRIP" SUR PIÉTEMENT

FRA. Système de signalisation d'intérieur en aluminium anodisé et verre. La pince est disponible en divers formats, version murale, sur table ou avec piétement. Livré avec une clé allen. Picto et texte non inclus.



ICONOS

PICTOGRAMAS
ICONS - ICONES



Rotulable
Inscribable
Inscriptable



No rotulable
Not inscribable
Non-inscriptable



Escritura con tiza
Chalk writing
Ecriture à la craie



Trazo digital
Digital use
Trait digital



Blocs de papel
Paper blocs
Blocs du papier



Personalizable
Customizable
Personnalisé



Magnético
Magnetic
Magnétique



No magnético
Not magnetic
Non-magnétique



Perforable
Suitable for pins
Aptes aux punnaises



Adhesivo
Adhesive
Adhésif



Doble cara
Double sided
Double face



Sujección incluida
Fitting included
Ferrures inclus



Puerta abatible vert.
Vert. swing door
Portes battante vert.



Puerta abatible hor.
Hor. swing door
Portes battante hor.



Incluye ruedas
Castors included
Avec roulettes



Incluye ruedas
Castors included
Avec roulettes



Ajustable en altura
Adjustable height
Régable en hauteur



Volteable
Flip - flop
Volteable



Puerta corredera
Sliding doors
Portes coulissantes



Incluye cerradura
Lock included
Serrure incluse



Sistema seguridad
Security system
Serrure de sécurité



Resistente
Weatherproof
Résistant



Inflamable
Flammable
Inflammable



Kit de iluminación
Light kit
Kit lumière

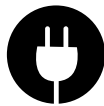

Kit de iluminación
Light kit
Kit lumière



Incluye herramientas
Tools included
Visserie inclus



Incluye nivelador
Adjustable base
Socles ajustables









Acústico
Acoustic
Acoustique



COLORES

COLORES
COLOUR CHART - COULEURS

| | | | | | | |
|------------------------------------------------------------------------------------------------------------------------------------------------------|----------------------------------------------------------------------------------------------------------------------------------------------------------|----------------------------------------------------------------------------------------------------------------------------------------------------------|-------------------------------------------------------------------------------------------------------------------------------------------------------------------|--------------------------------------------------------------------------------------------------------------------------------------------------------------|--------------------------------------------------------------------------------------------------------------------------------------------------------|----------------------------------------------------------------------------------------------------------------------------------------------------------------------|
| Superficie de pizarra Writing surface Superficie d'écriture |  RAL 9003 Blanca - /BL White - /BL Blanc - /BL |  RAL 5012 Azul claro - /AZ Sky blue - /GR Bleu - /GR |  RAL 7012 Gris - /GR Grey - /GR Gris - /GR |  RAL 6028 Verde - /VD Green - /VD Vert - /VD |  RAL 5023 Azul - /AZ Blue - /AZ Bleu - /AZ |  RAL 7015 Negra - /NG Black - /NG Noir - /NG |
| Superficie de cristal Glass board Panneau de verre |  RAL 9003 Blanca - /BL White - /BL Blanc - /BL |  RAL 1016 Amarillo - /AM Yellow - /AM Jaune - /AM |  RAL 6019 Verde - /VD Green - /VD Vert - /VD |  RAL 3015 Rosa - /RS Pink - /RS Rose - /RS |  RAL 7035 Azul - /AZ Blue - /AZ Bleu - /AZ |  RAL 2012 Naranja - /NJ Orange - /NJ Orange - /NJ |
|  RAL 9006 Gris - /GR Grey - /GR Gris - /GR |  RAL 1011 Marrón - /MR Brown - /MR Marron - /MR | Color de lacado Lacquer colour Couleur laquée |  RAL 9003 Blanca - /BL White - /BL Blanc - /BL |  RAL 9006 Gris - /GR Grey - /GR Gris - /GR |  RAL 9011 Negra - /NG Black - /NG Noir - /NG |  RAL 1013 Amarillo - /AM Yellow - /AM Jaune - /AM |
|  RAL 3024 Rojo - /RJ Red - /RJ Rouge - /RJ |  RAL 5012 Azul - /AZ Blue - /AZ Bleu - /AZ |  RAL 6016 Verde - /VD Green - /VD Vert - /VD | Color de rotulación Sign systems colour Couleur signalétique |  RAL 9010 Blanco - 01 White - 01 Blanc - 01 |  RAL 1023 Amarillo - 29 Yellow - 29 Jaune - 29 |  RAL 2002 Naranja - 34 Orange - 34 Orange - 34 |
|  RAL 3024 Rojo - 19 Red - 19 Rouge - 19 |  RAL 3004 Burdeos - 55 Bordeaux - 55 Bordeaux - 55 |  RAL 6018 Verde - 78 Green - 78 Vert - 78 |  RAL 6017 Verde oscuro - 20 Dark green - 20 Vert foncé - 20 |  RAL 5021 Turquesa - 76 Turquoise - 76 Turquoise - 76 |  RAL 5024 Azul - 76 Blue - 76 Bleu - 76 |  RAL 5017 Azul oscuro - /AZ Dark blue - /AZ Bleu foncé - /AZ |
|  RAL 4001 Violeta - 63 Violet - 63 Violet - 63 |  RAL 7036 Gris - 70 Grey - 70 Gris - 70 |  RAL 9004 Negro - 57 Black - 57 Noir - 57 | | | | |



GRACIAS

POR TU CONFIANZA

THANK YOU OR YOUR CONFIDENCE - MERCI POUR VOTRE CONFIANCE

ESP. A vosotros, clientes. Gracias por vuestra confianza y apoyo. Por muchos años más.

ENG. To you, our partners. Thank you for your confidence and support. To many more years.

FRA. A vous, chez clients. Merci pour votre confiance et support. Pour beaucoup plus d'années.



Planning Sisplamo SL
Polígon Industrial Pla d'en Coll
C/ Camí de la Font Freda 17, nave 4
08110 Montcada i Reixac
Barcelona

www.madedesign.es
www.planningsisplamo.com